

Alabama 28 (131 7/8" x 108 1/4")

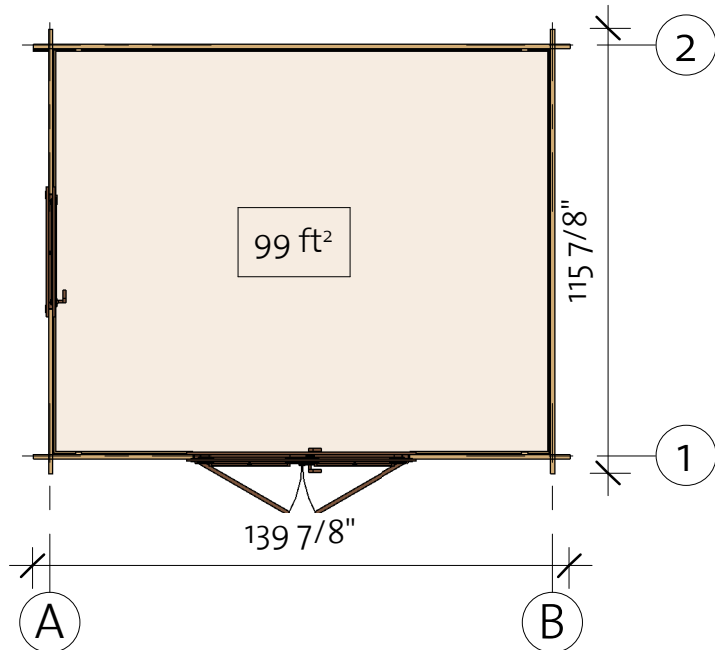
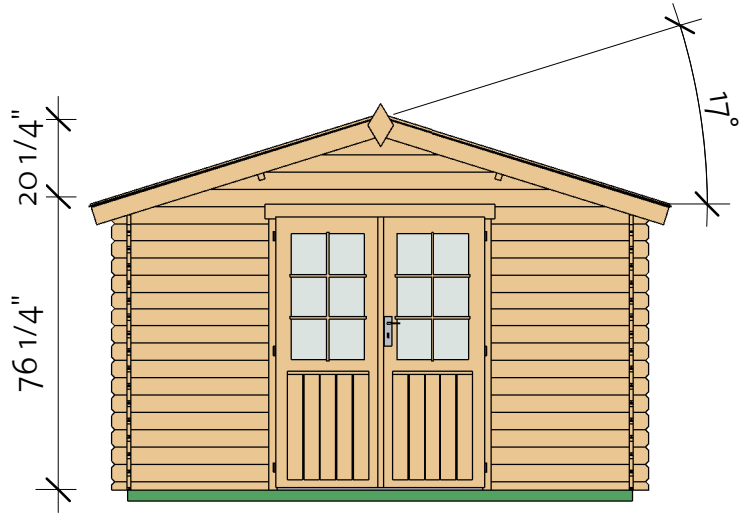

4000008_20601

EZ Log Structures
Do-It-Yourself Building Kits

Alabama 28 (131 7/8" x 108 1/4")

Foundation

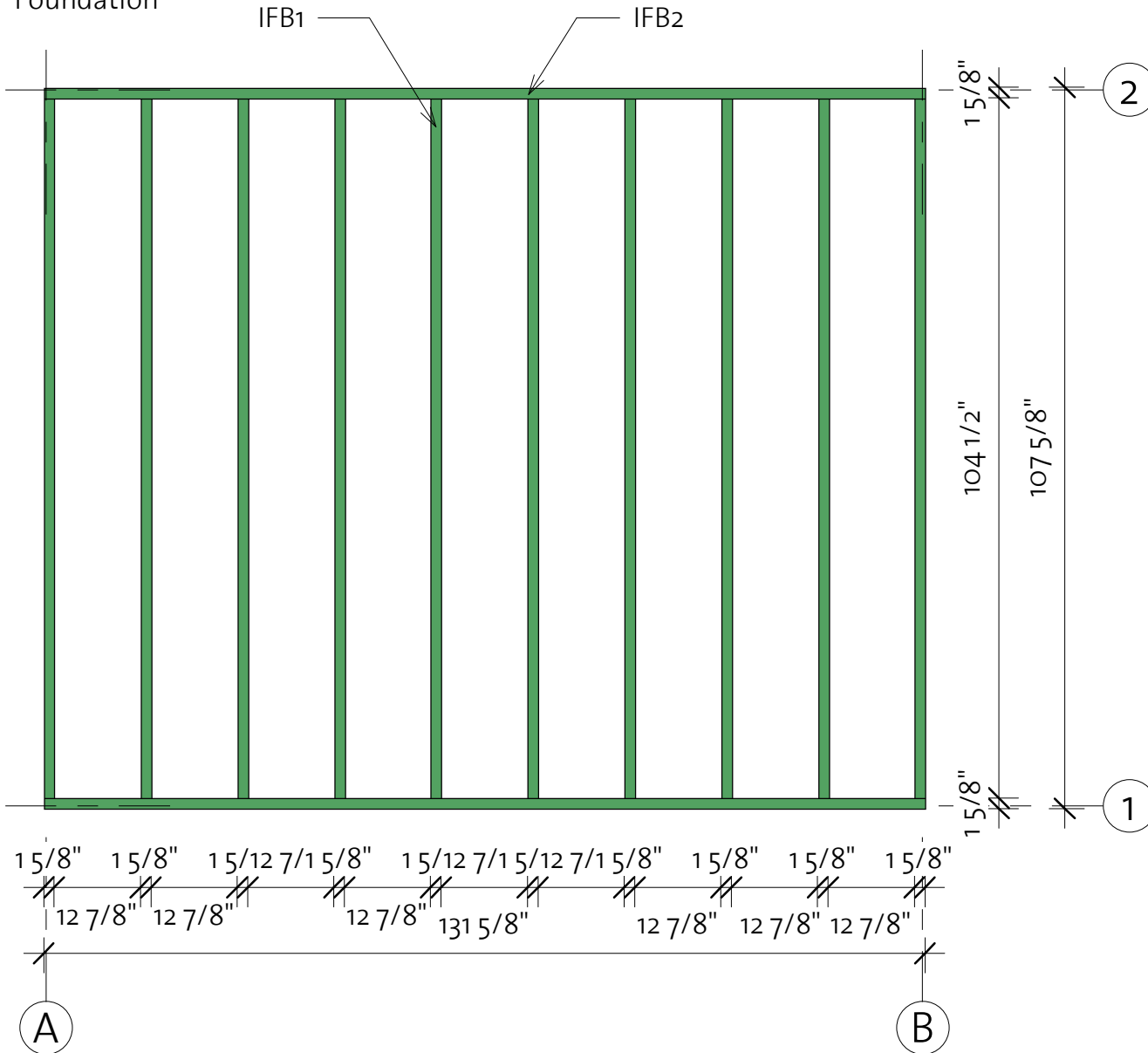

Impregnated foundation beams				
Mark	Type	Profile	Length	Count

IFB1	IFB 40x70		104 1/2"	10
IFB2	IFB 40x70		131 5/8"	2

Alabama 28 (131 7/8" x 108 1/4")

Floor Plan

① Baseboard

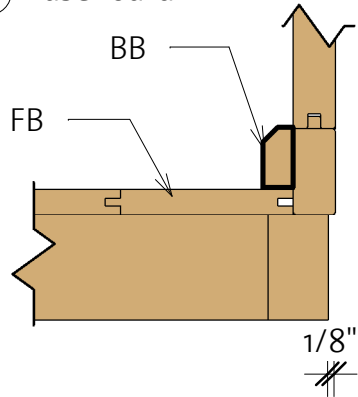

Floor Schedule

Mark	Type	Profile	Count	Length
------	------	---------	-------	--------

FB	FB 17x114		25	129 5/8"
----	--------------	---	----	-------------

BB1	BB 20x40		2	108 1/4"
BB2	BB 20x40		2	131 7/8"

4000008_20601

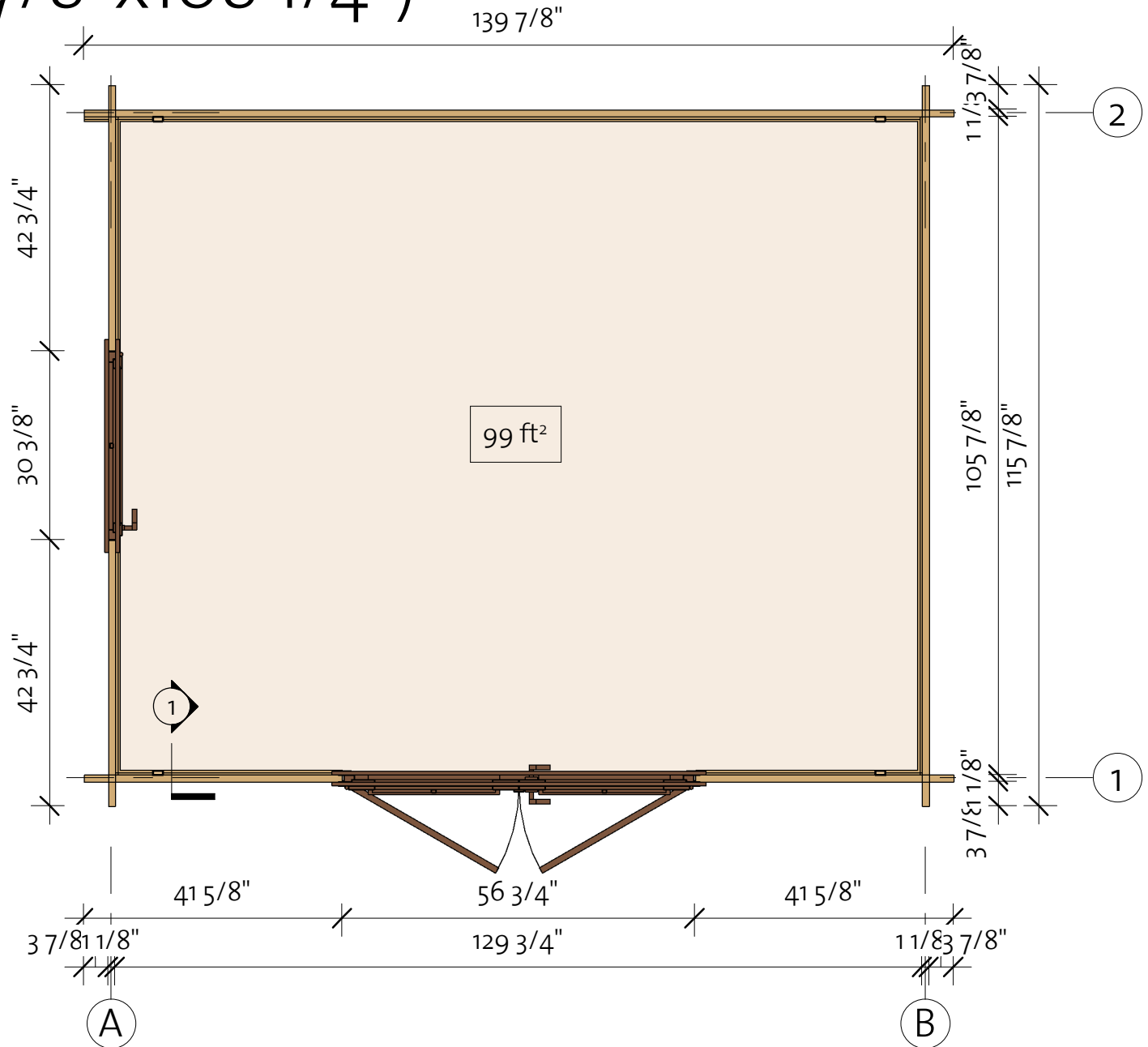

Alabama 28 (131 7/8" x 108 1/4")

Wall 1

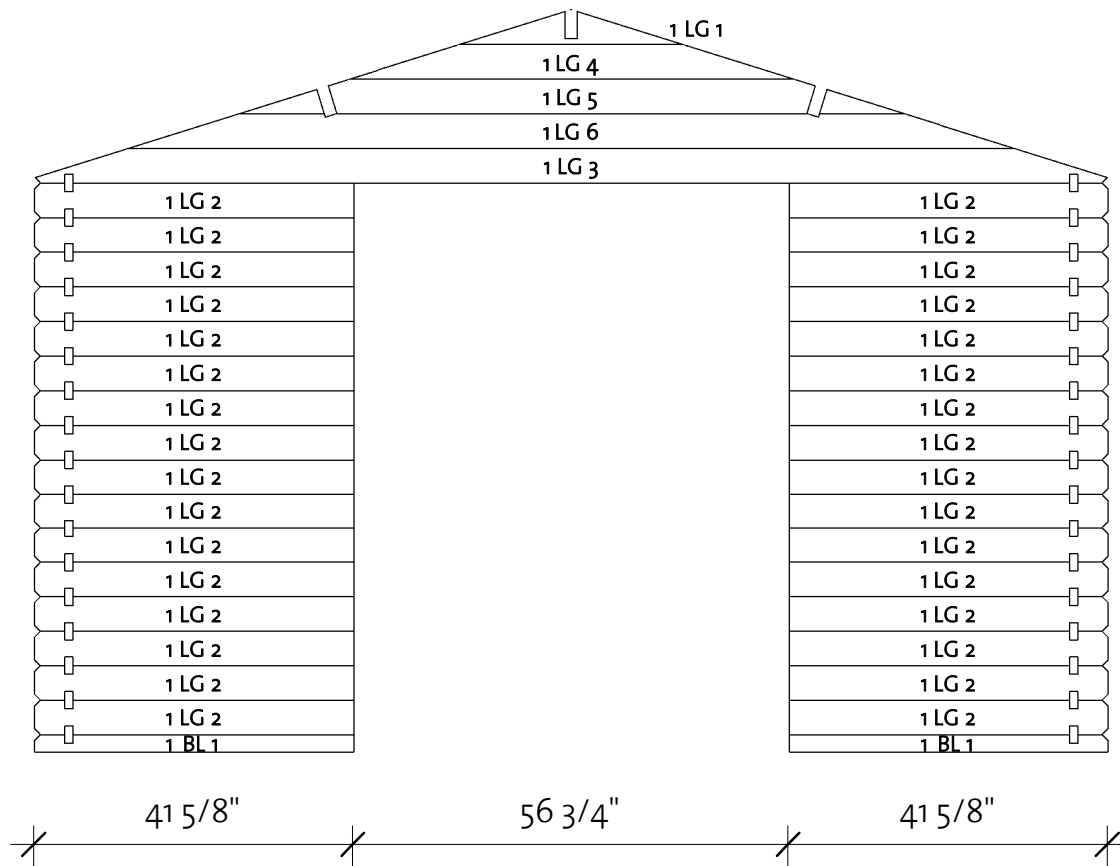
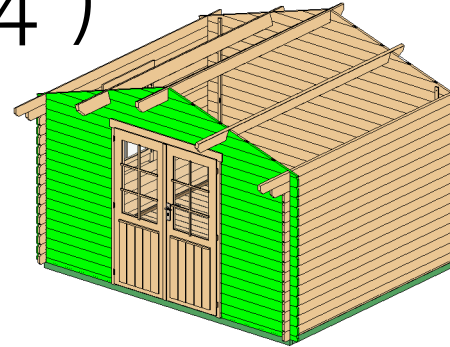

Wall 1			
Mark	Profile	Count	Cut Length

1BL 1	28x57	2	41 5/8"
1LG 1 *	28x114	1	29"
1LG 2	28x114	32	41 5/8"
1LG 3 *	28x114	1	139 5/8"
1LG 4 *	28x114	1	57 3/4"
1LG 5 *	28x114	1	86 5/8"
1LG 6 *	28x114	1	115 3/8"

*Gable-delivered premounted

Log Profile Wall 1	
Profile	Profile

28x57	
28x114	

Alabama 28 (131 7/8"x108 1/4")

Wall 2

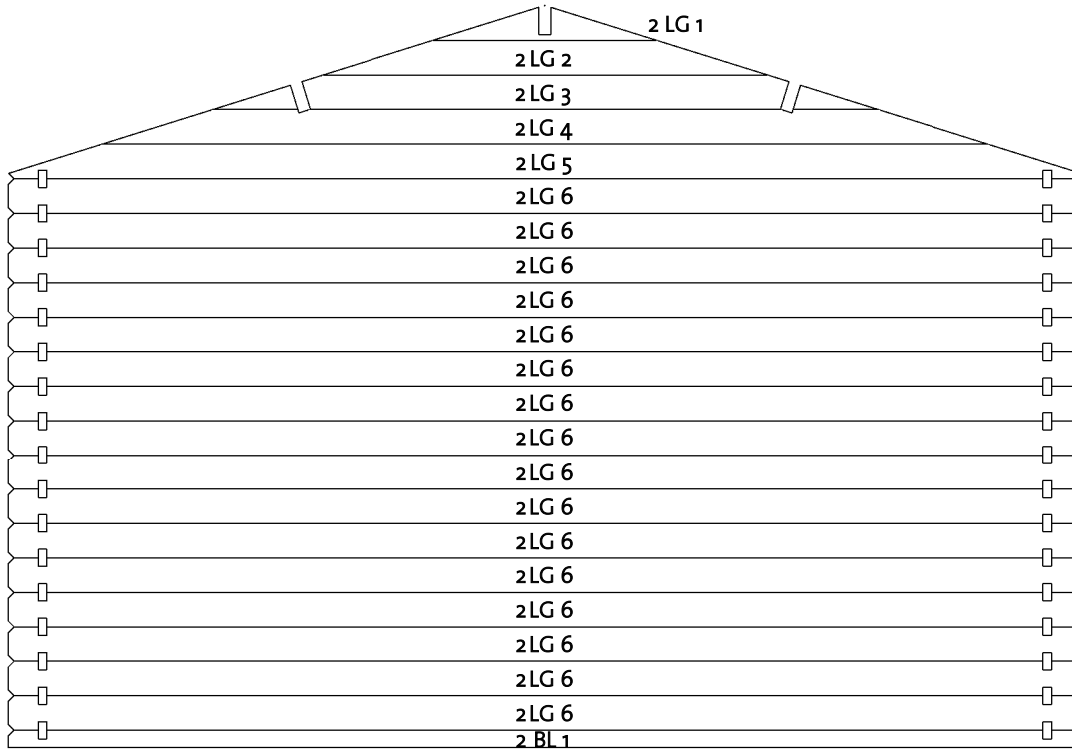
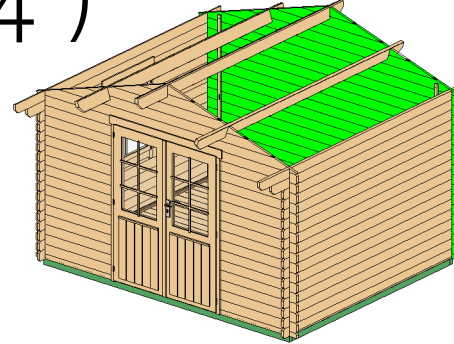



Wall 2			
Mark	Profile	Count	Cut Length

2BL 1	28x57	1	139 7/8"
2LG 1 *	28x114	1	29"
2LG 2 *	28x114	1	57 3/4"
2LG 3 *	28x114	1	86 5/8"
2LG 4 *	28x114	1	115 3/8"
2LG 5 *	28x114	1	139 5/8"
2LG 6	28x114	16	139 7/8"

*Gable-delivered premounted

Log Profile Wall 2	
Profile	Profile

28x57	
28x114	

Alabama 28 (131 7/8" x 108 1/4")

Wall A

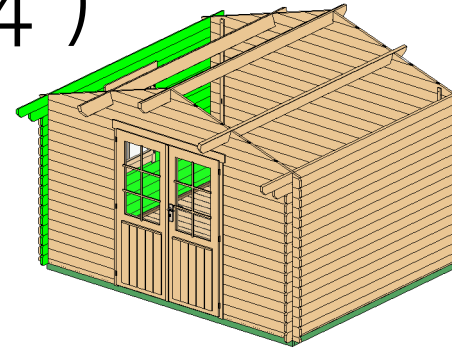

Wall A			
Mark	Profile	Count	Cut Length
ALG 1	28x114	18	42 3/4"
ALG 2	28x114	6	115 7/8"
ALG 3	28x114	1	123 3/4"
ATL 1	28x114	1	135 5/8"

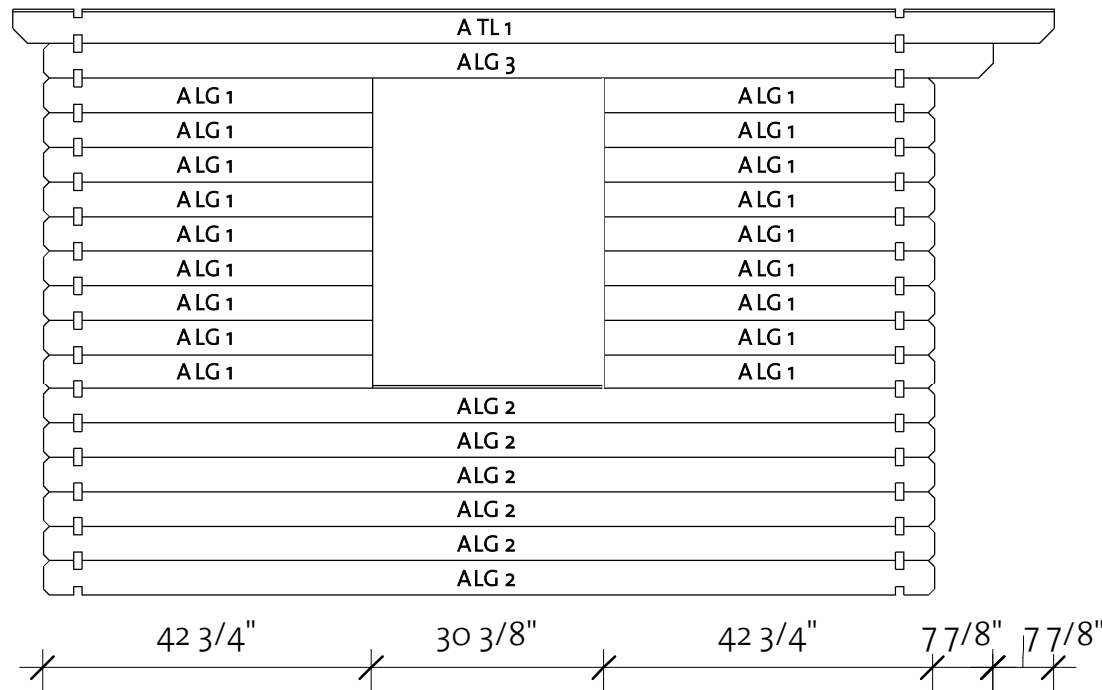

Log Profile Wall A	
Profile	Profile

28x114	
28x114	

Alabama 28 (131 7/8" x 108 1/4")

Wall B

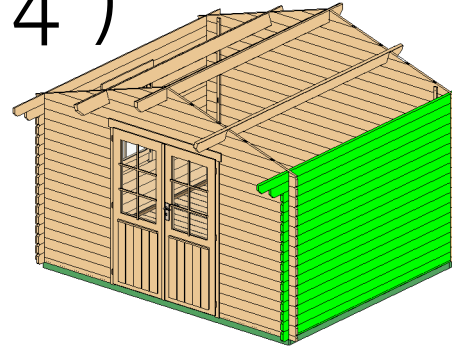

Wall B			
Mark	Profile	Count	Cut Length

BLG 1	28x114	15	115 7/8"
BLG 2	28x114	1	123 3/4"
BTL 1	28x114	1	135 5/8"

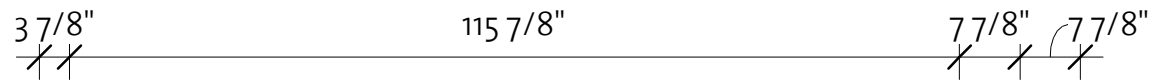
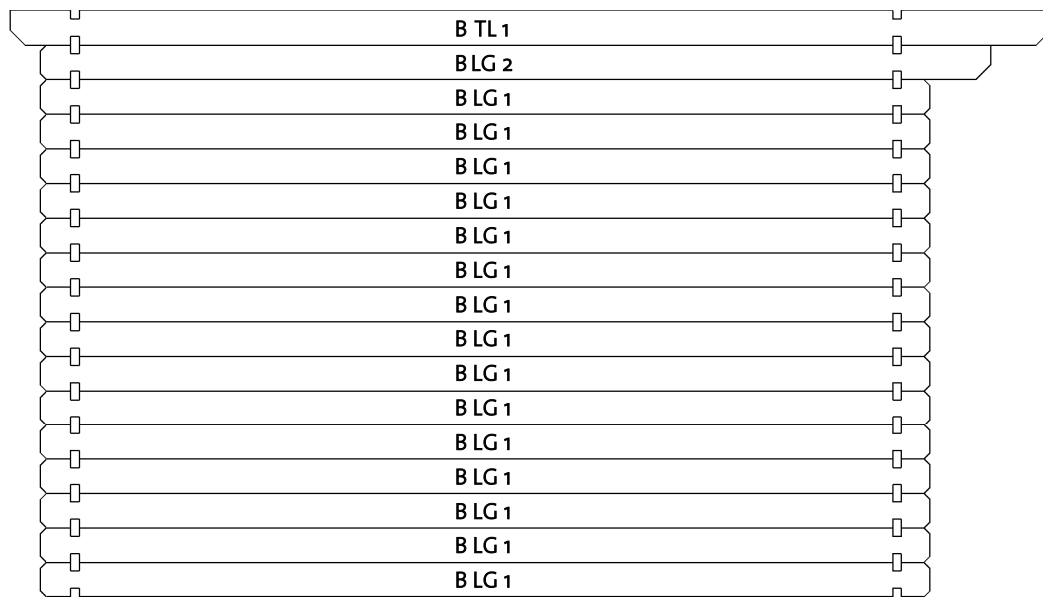





Log Profile Wall B	
Profile	Profile

28x114	
28x114	

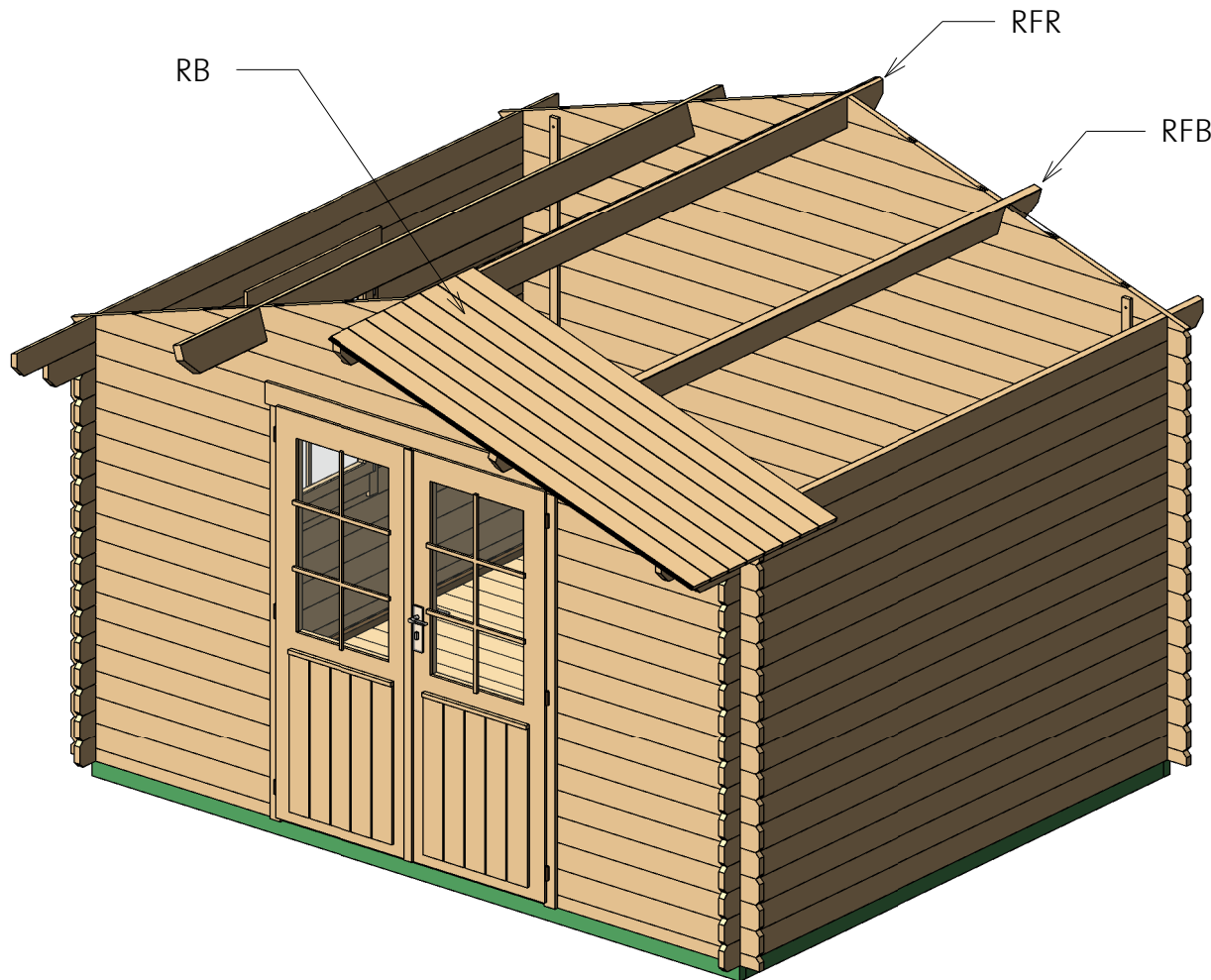
Alabama 28 (131 7/8" x 108 1/4")

Roof 1



Roof				
Mark	Type	Profile	Count	Length
RFR	Ridge 40X143		1	135 5/8"
RFB	Beam 40X143		2	135 5/8"
RB	17X114		64	77 1/4"

Alabama 28 (131 7/8" x 108 1/4")

Roof 2

① Fascia

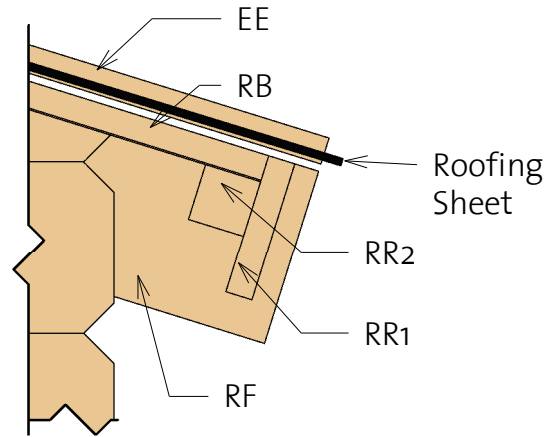
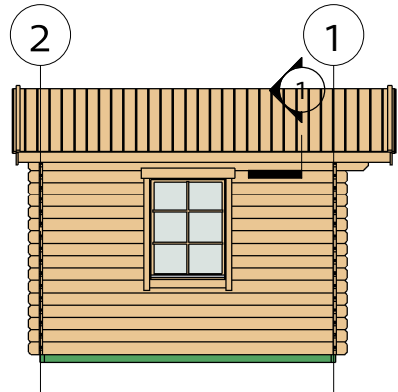



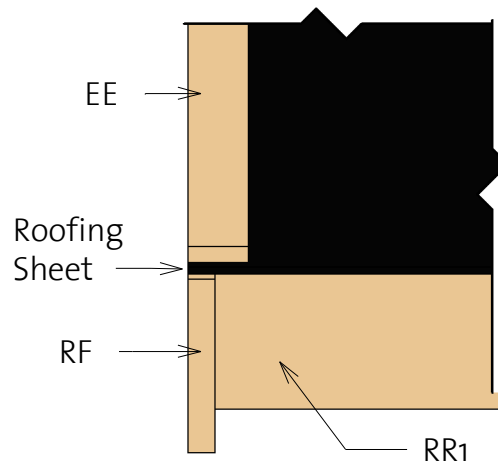
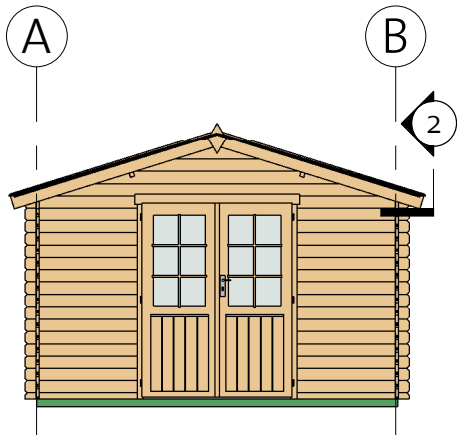



























② Roof Reinforcement



Fascia Schedule				
Mark	Type	Profile	Count	Length
EE	Eave Edging 18x40		4	78 3/4"
RF	Roof Fascia 18x120		4	78 3/4"
RR1	Roof reinforcement 18x95		2	135 5/8"
RR2	Roof reinforcement 38x38		2	135 5/8"

Alabama 28 (131 7/8"x108 1/4")

List of all items 1

2	BL 1	Log 28x57		1	139 7/8"
2	LG 6	Log 28x114		16	139 7/8"
	RFB	Beam 40x143	 	2	135 5/8"
	RFR	Ridge 40x143	 	1	135 5/8"
A	TL 1	Log 28x114	 	1	135 5/8"
B	TL 1	Log 28x114	 	1	135 5/8"
	IFB2	IFB 40x70	 	2	131 5/8"
	FB	FB 17x114	 	25	129 5/8"
B	LG 2	Log 28x114		1	123 3/4"
A	LG 3	Log 28x114		1	123 3/4"
B	LG 1	Log 28x114		15	115 7/8"
A	LG 2	Log 28x114		6	115 7/8"
	IFB1	IFB 40x70	 	10	104 1/2"
	RB	17x114	 	64	77 1/4"
A	LG 1	Log 28x114		9	42 3/4"
A	LG 1	Log 28x114		9	42 3/4"
1	BL 1	Log 28x57		2	41 5/8"
1	LG 2	Log 28x114		16	41 5/8"
1	LG 2	Log 28x114		16	41 5/8"
RR1	Roof reinforcement 18x95			2	135 5/8"
RR2	Roof reinforcement 38x38			2	135 5/8"
EE	Eave Edging 18x40			4	78 3/4"
RF	Roof Fascia 18x120			4	78 3/4"

4000008_20601

Alabama 28 (131 7/8" x 108 1/4")



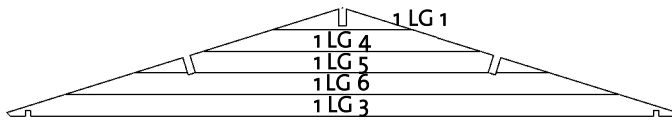

List of all items 2

① Gable 1

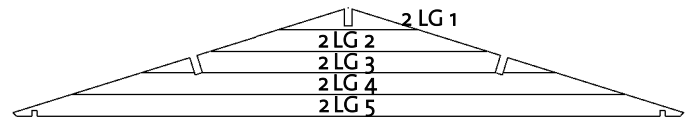

② Gable 2



BB1	BB 20x40			2	108 1/4"
BB2	BB 20x40			2	131 7/8"

Windboard 18x40			4	86 5/8"
-----------------	---	--	---	---------



BDD5R	Basic double door 5 right	56 1/8"	72 1/4"	1
-------	---------------------------	---------	---------	---





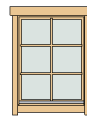

DCB6	Door crossbar 6	--	--	2
------	-----------------	----	----	---

BW1R	Basic window 1 right	30 1/8"	39"	1
------	----------------------	---------	-----	---

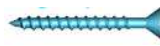

WCB6	Window crossbar 6	--	--	1
------	-------------------	----	----	---

Hitblock	300-400 mm		
Screws	5,0 x 70		10
Bolts	M8 x 60		12
Nails	1,4 x 40		30
Screws	6,0 x 140		45
Screws	4,0 x 40		565