

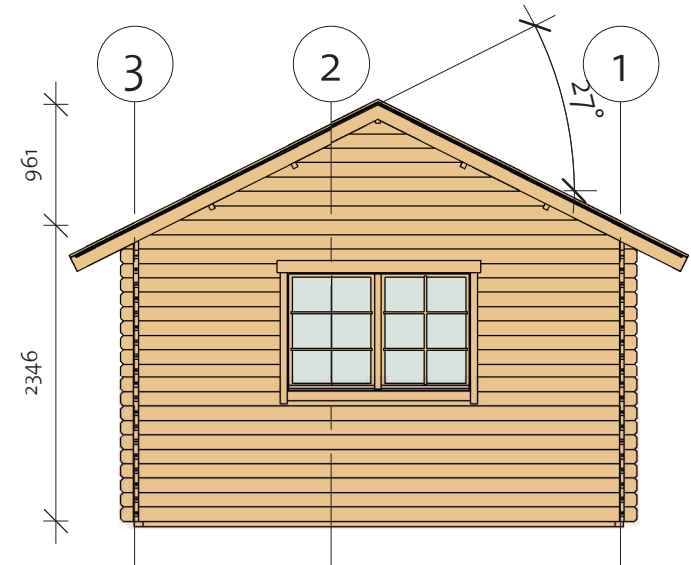

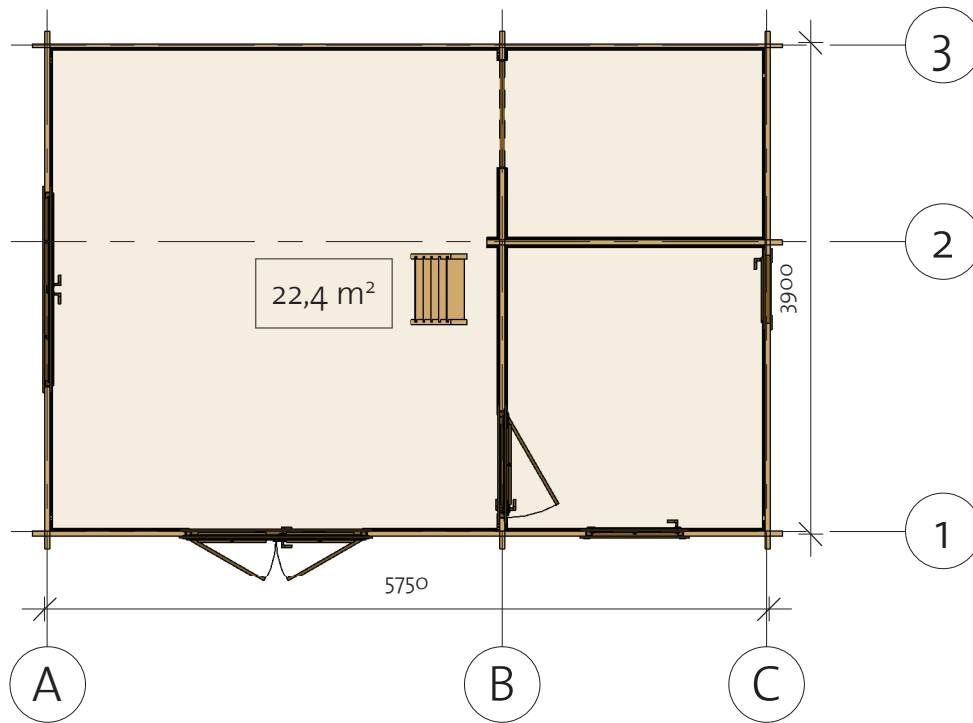

# Caroline Lofted 40 (575x390)

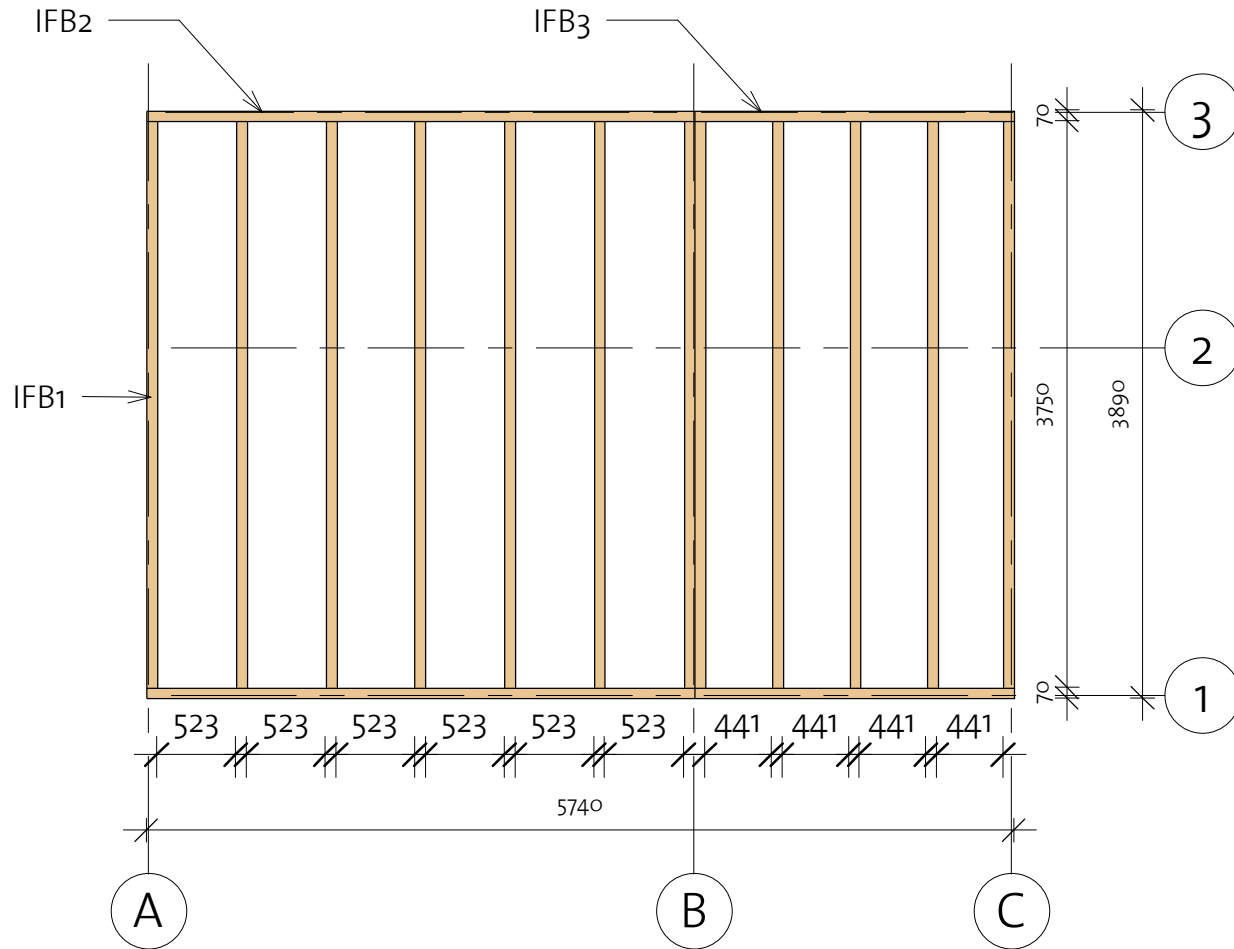

# Caroline Lofted 40 (575x390)

Foundation





Impregnated foundation beams				
Mark	Type	Profile	Count	Length
IFB1	IFB 70x40		12	3750
IFB2	IFB 70x40		2	3625
IFB3	IFB 70x40		2	2115

# Caroline Lofted 40 (575x390)

Floor Plan

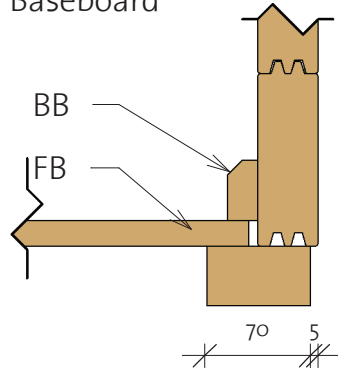
① Baseboard



Floor Schedule				
Mark	Type	Profile	Count	Length
FB1	FB 17x114		60	2054
FB2	FB 17x114		36	3564
FB3	FB 17x114		9	2097
BB1	BB 20x40		9	3900
BB2	BB 20x40		4	2200

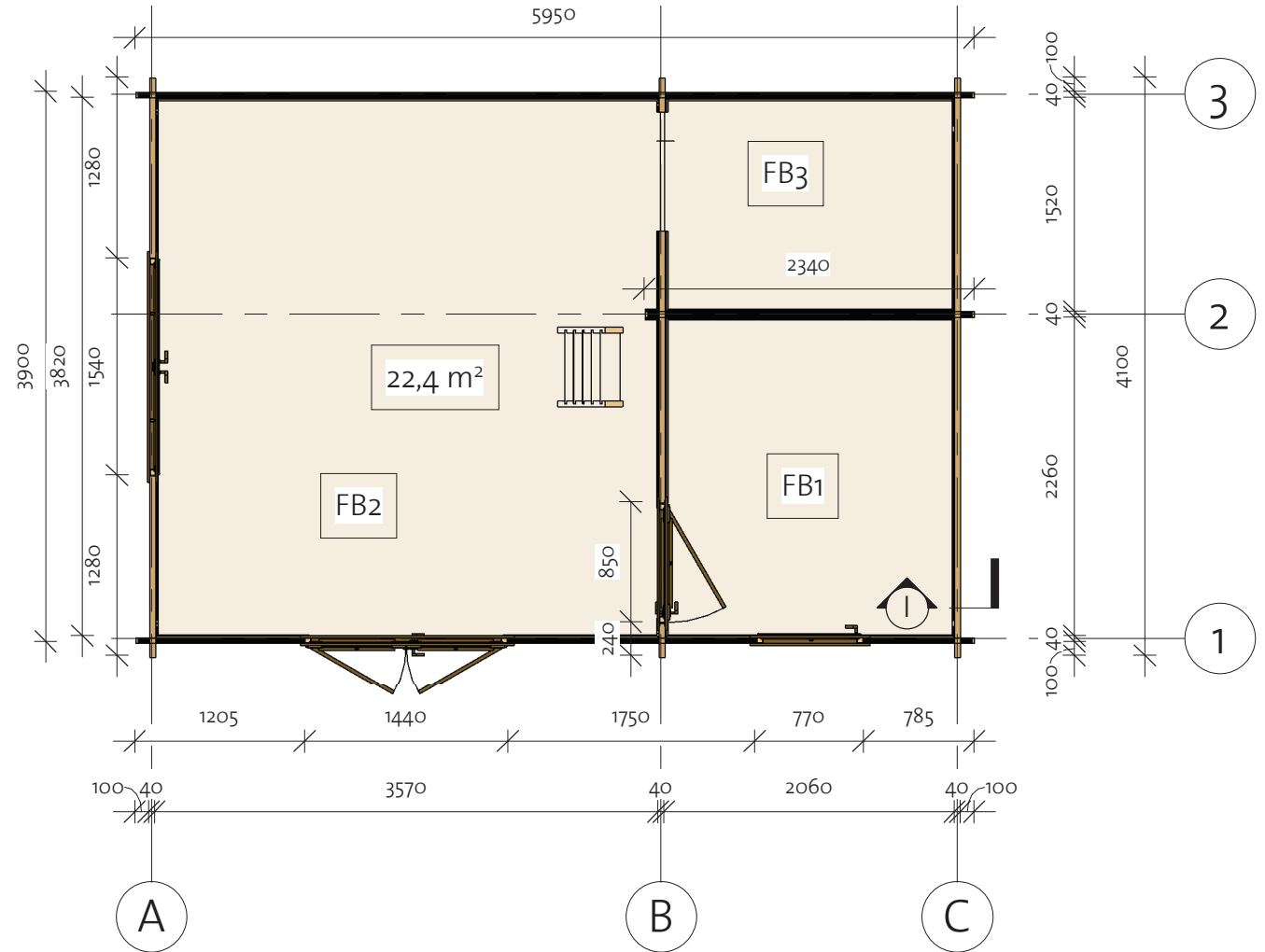

# Caroline Lofted 40 (575x390)

Wall 1

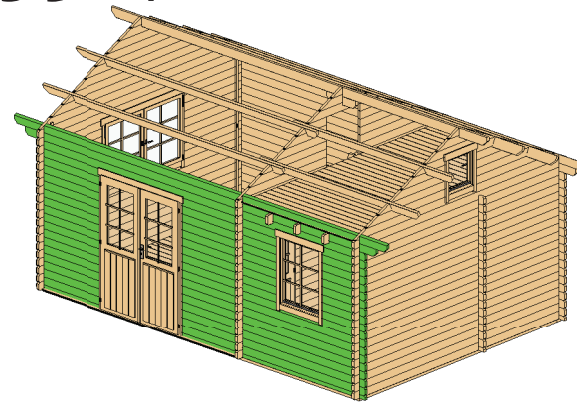

Wall 1			
Mark	Profile	Count	Cut Length

1BL-1	40X57	1	1205
1BL-2	40X57	1	3305
1LG-1	40X114	9	785
1LG-2	40X114	17	1205
1LG-3	40X114	9	1750
1LG-4	40X114	1	2420
1LG-5	40X114	8	3305
1LG-6	40X114	1	3930
1LG-7	40X114	1	5950
1TL-1	40X123	1	2620
1TL-2	40X123	1	4130

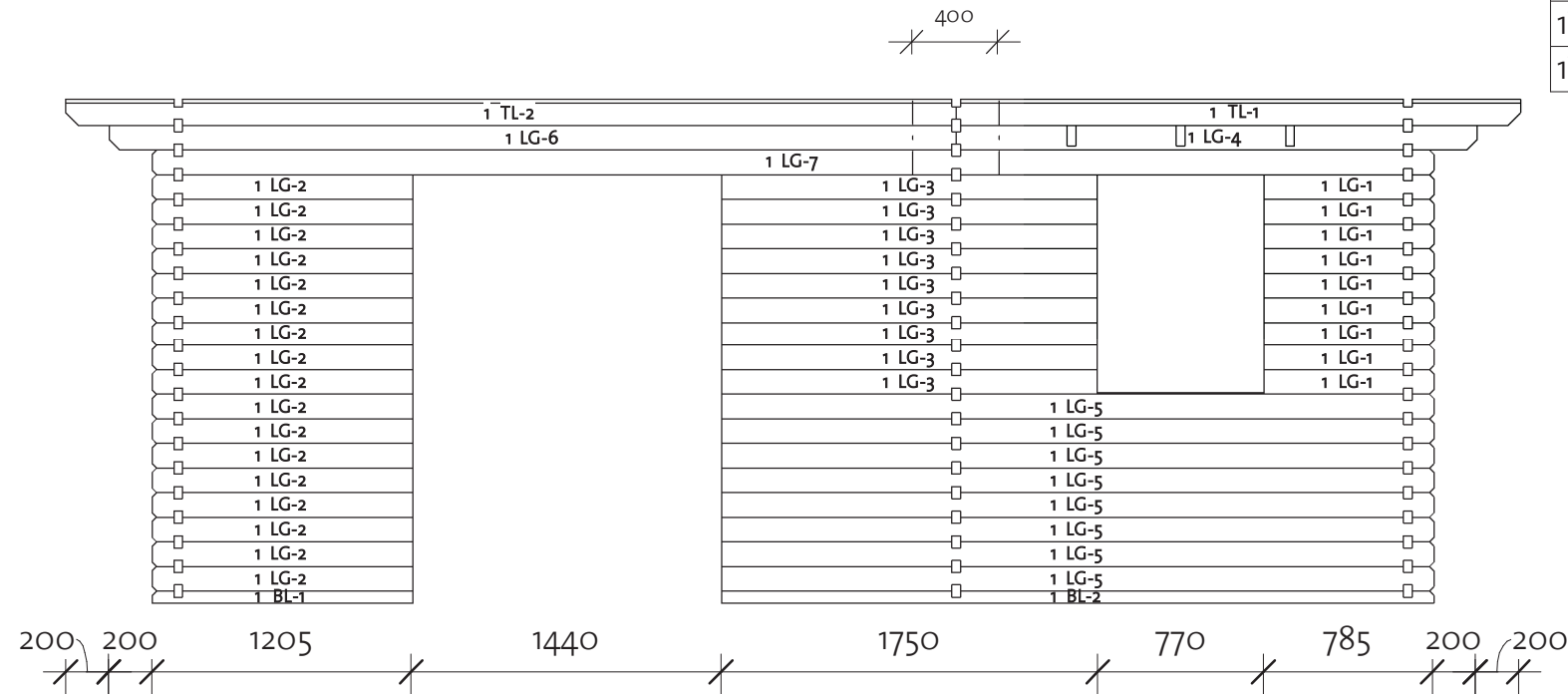

Log Profile Wall 1	
Profile	Profile

40X57	
40X114	
40X123	

# Caroline Lofted 40 (575x390)

Wall 2

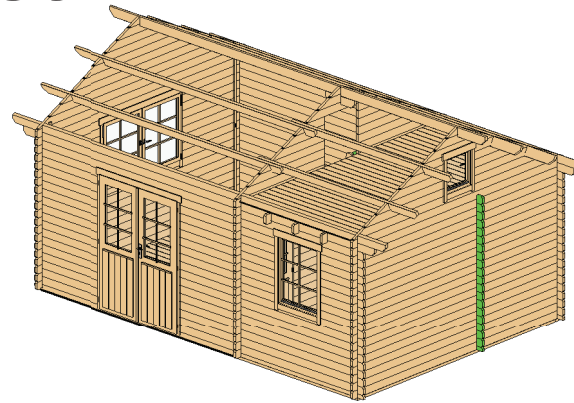

Wall 2			
Mark	Profile	Count	Cut Length

2BL-1	40X57	1	2340
2LG-1	40X114	18	2340
2TL-1	40X114	1	2340

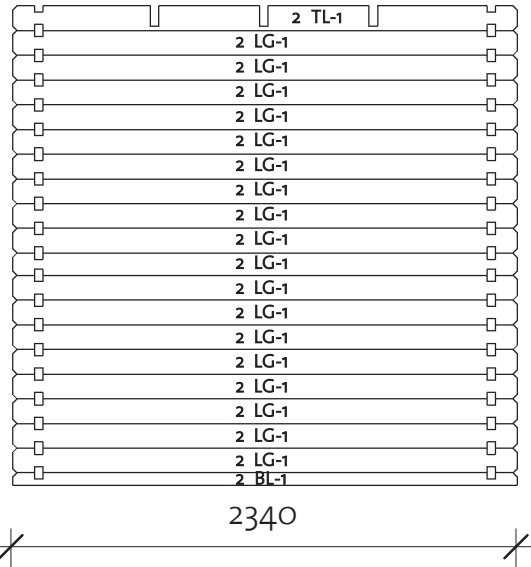

Log Profile Wall 2	
Profile	Profile

40X57	
40X114	
40X114	

# Caroline Lofted 40 (575x390)

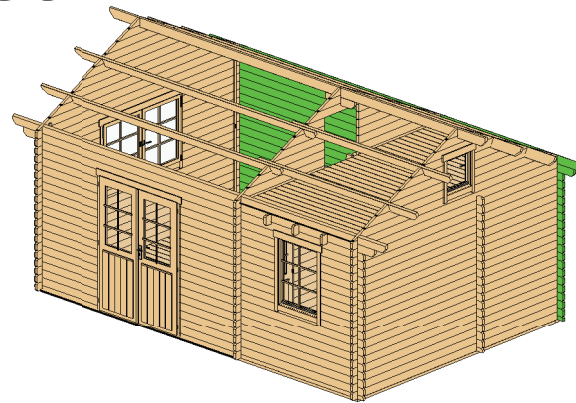

Wall 3



Wall 3			
Mark	Profile	Count	Cut Length

3BL-1	40X57	1	5950
3LG-1	40X114	1	2420
3LG-2	40X114	1	3930
3LG-3	40X114	17	5950
3LG-4	40X114	1	5950
3TL-1	40X123	1	2620
3TL-2	40X123	1	4130

Log Profile Wall 3	
Profile	Profile

40X57	
40X114	
40X123	

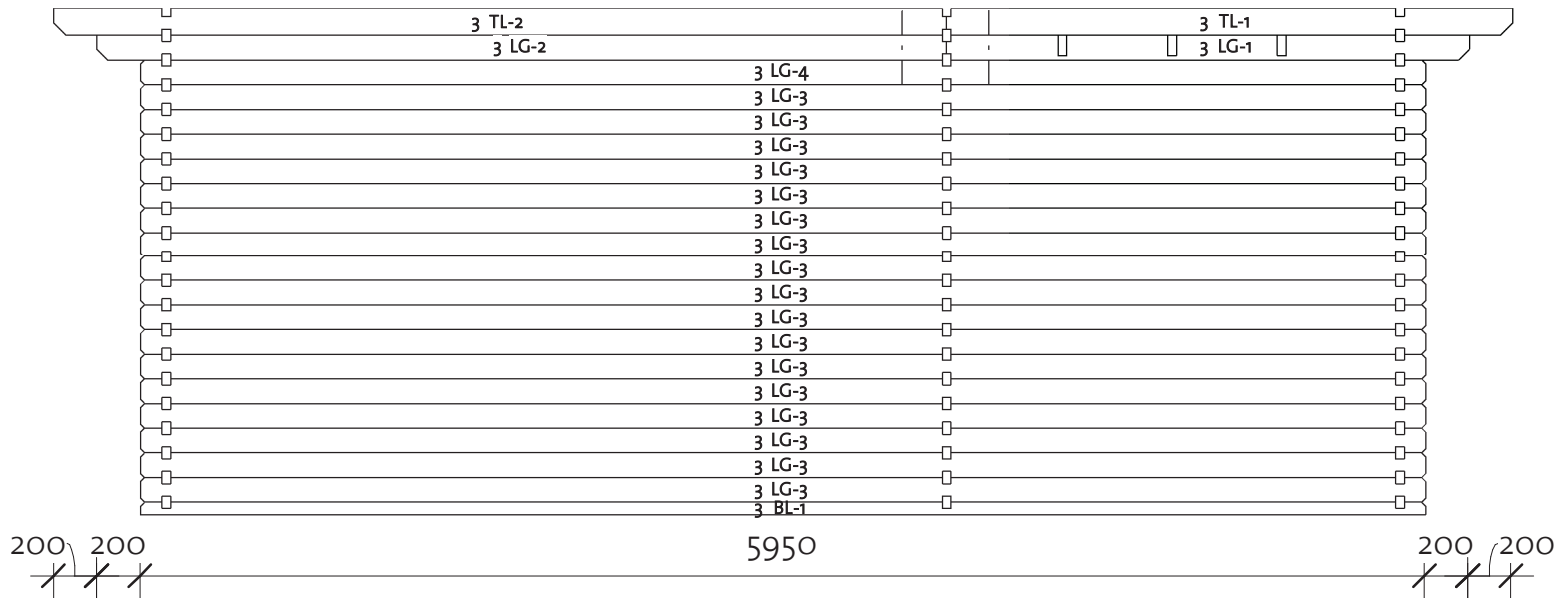

# Caroline Lofted 40 (575x390)

Wall A

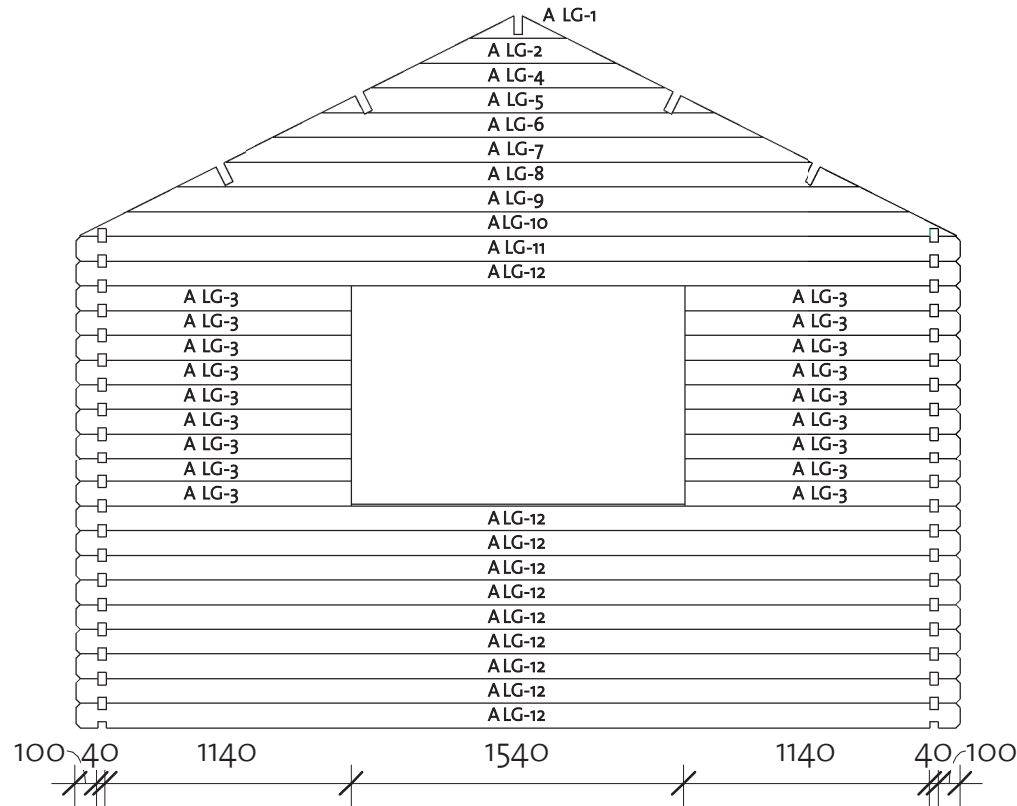
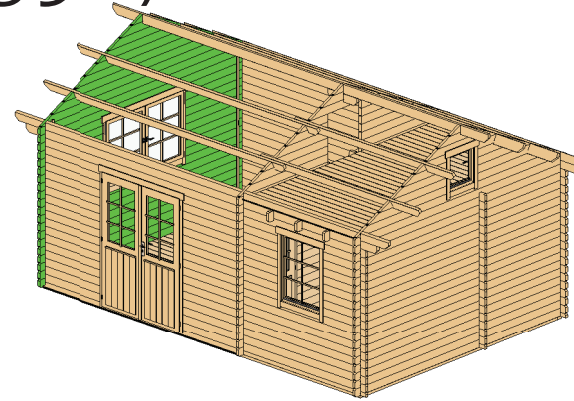

Wall A			
Mark	Profile	Count	Cut Length

ALG-1 *	40X114	1	455
ALG-2 *	40X114	1	908
ALG-3	40X114	18	1280
ALG-4 *	40X114	1	1362
ALG-5 *	40X114	1	1815
ALG-6 *	40X114	1	2269
ALG-7 *	40X114	1	2722
ALG-8 *	40X114	1	3176
ALG-9 *	40X114	1	3629
ALG-10 *	40X114	1	4068
ALG-11 *	40X114	1	4100
ALG-12	40X114	10	4100

\* Gable - delivered premounted

Log Profile Wall A	
Profile	Profile

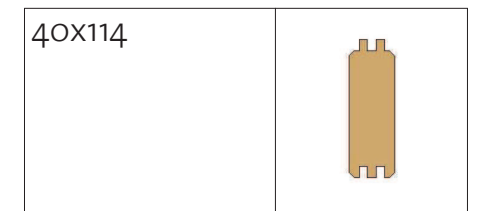

# Caroline Lofted 40 (575x390)

Wall B

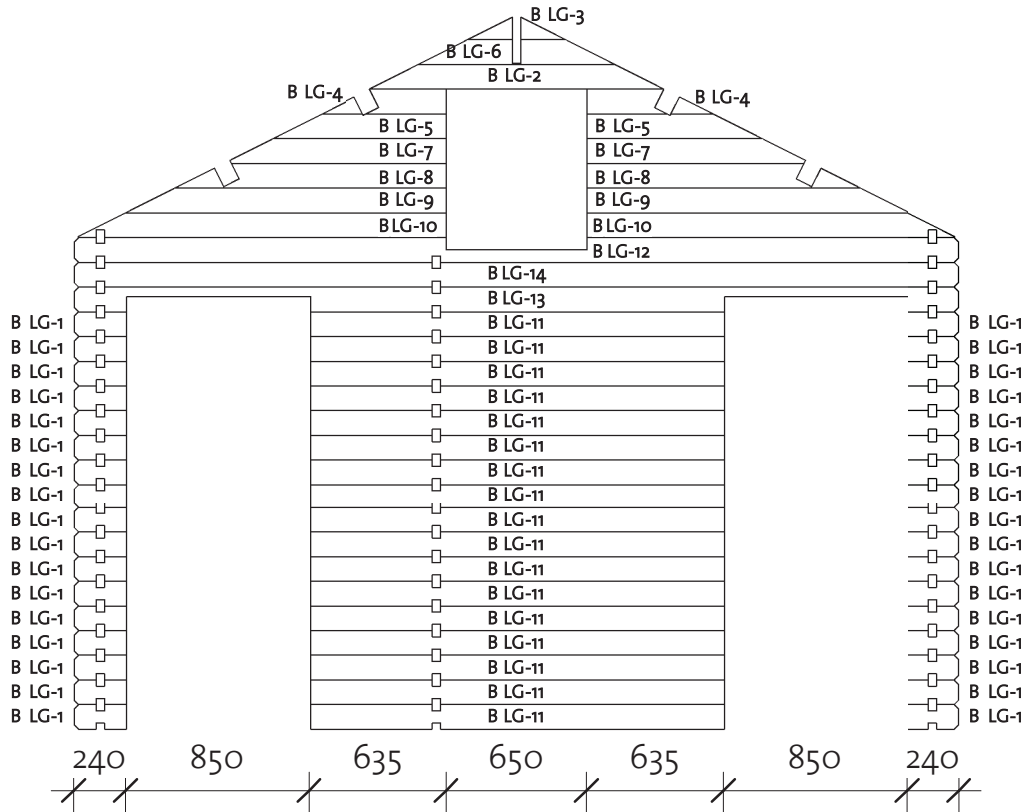
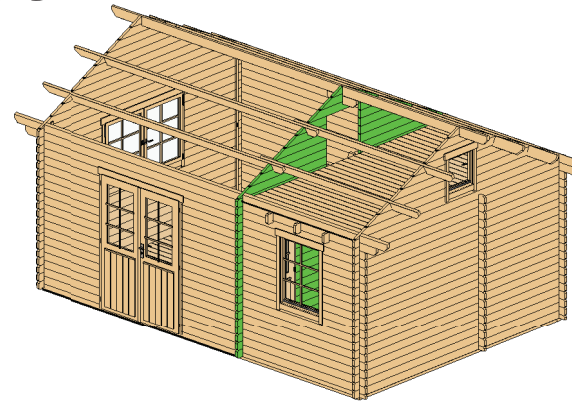

Wall B			
Mark	Profile	Count	Cut Length

BLG-1	40X114	34	240
BLG-2 *	40X114	1	1360
BLG-3 *	40X114	1	455
BLG-4 *	40X114	2	583
BLG-5 *	40X114	2	809
BLG-6 *	40X114	1	908
BLG-7 *	40X114	2	1008
BLG-8 *	40X114	2	1263
BLG-9 *	40X114	2	1490
BLG-10 *	40X114	2	1709
BLG-11	40X114	17	1920
BLG-12 *	40X114	1	4100
BLG-13	40X114	1	4100
BLG-14	40X114	1	4100

\* Gable - delivered premounted

Log Profile Wall B	
Profile	Profile

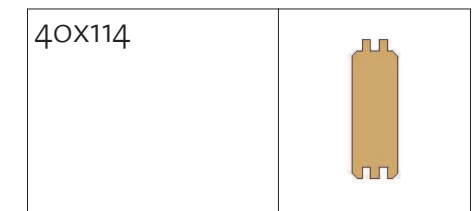



# Caroline Lofted 40 (575x390)

Wall C

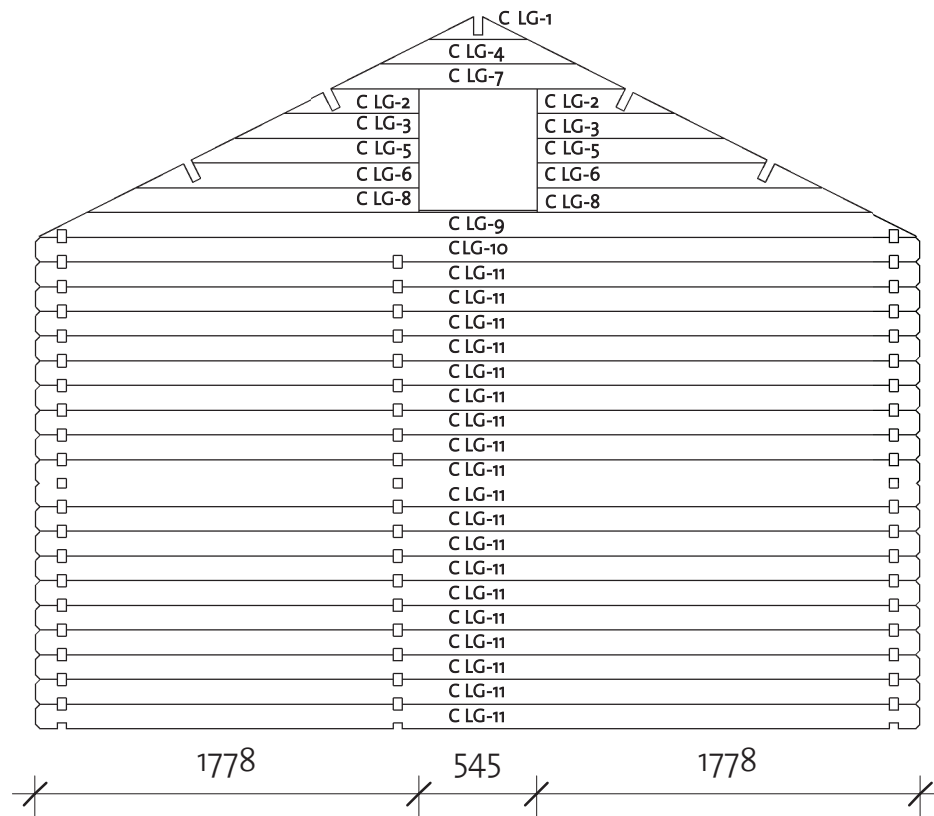
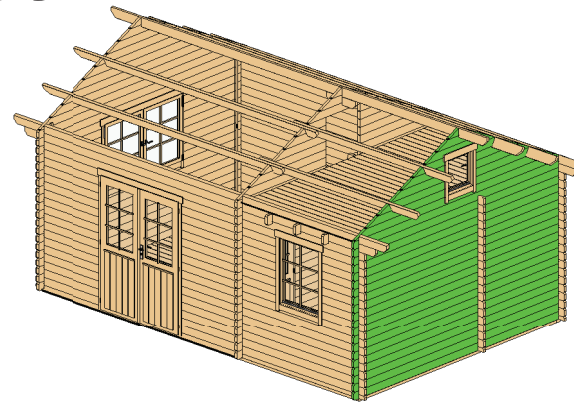

Wall C			
Mark	Profile	Count	Cut Length

CLG-1	* 40x114	1	455
CLG-2	* 40x114	2	635
CLG-3	* 40x114	2	862
CLG-4	* 40x114	1	908
CLG-5	* 40x114	2	1061
CLG-6	* 40x114	2	1315
CLG-7	* 40x114	1	1360
CLG-8	* 40x114	2	1542
CLG-9	* 40x114	1	4068
CLG-10	* 40x114	1	4100
CLG-11	40x114	19	4100

\* Gable - delivered premounted



Log Profile Wall C	
Profile	Profile

40X114	
--------	--

# Caroline Lofted 40 (575x390)

Roof 1

Second floor				
Mark	Type	Profile	Count	Cut Length

CB1	40x90		2	1520
CB2	40x90		2	2260
CB3	Ceiling beam 40x143		3	4100

Roof				
Mark	Type	Profile	Count	Length

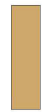
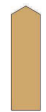
RB	17x114		120	2690
RFB1	Beam 40x143		4	2840
RFB2	Beam 40x143		4	4350
RFB3	Ridge 40x120		1	520
RFR1	Ridge 40x143		1	2620
RFR2	Ridge 40x143		1	4130

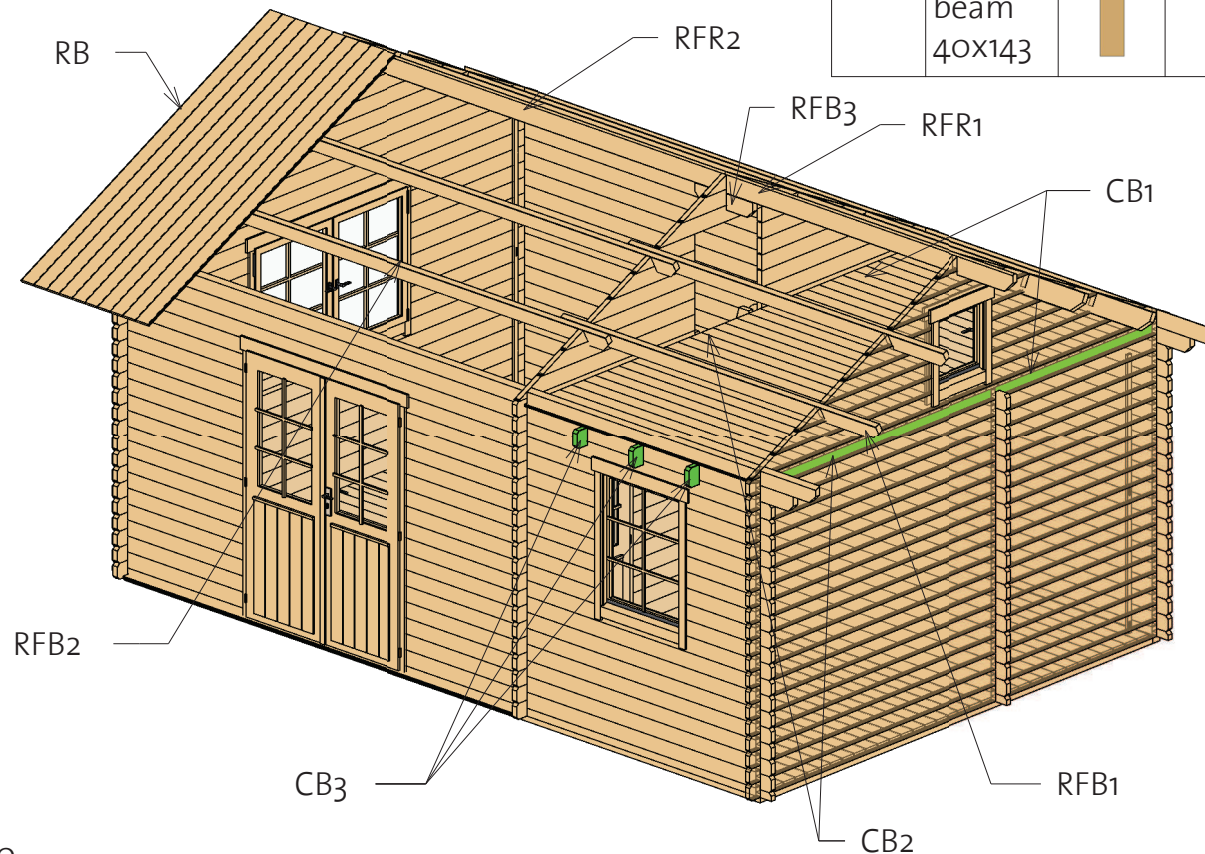

# Caroline Lofted 40 (575x390)

Roof 2

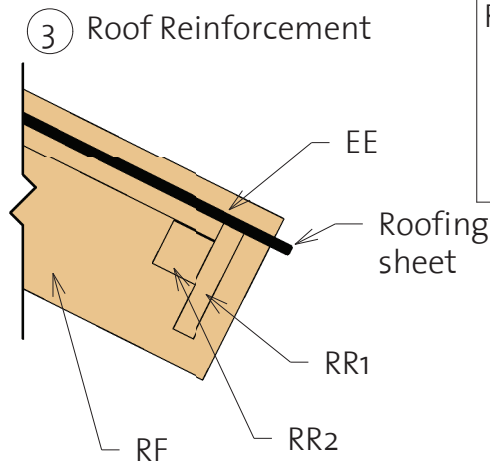
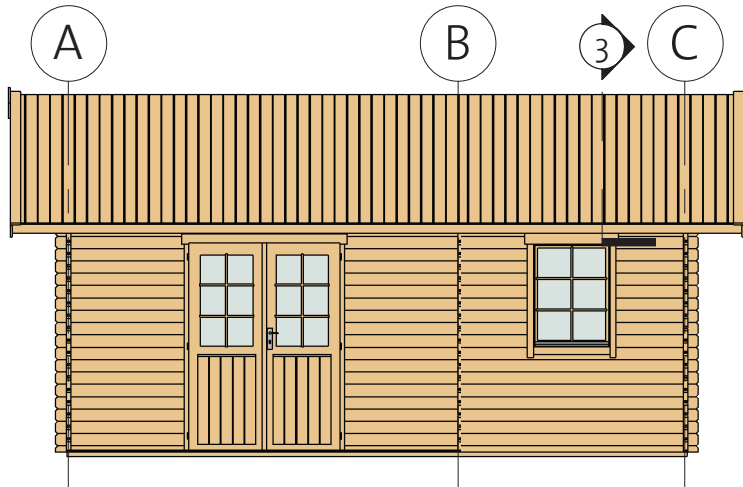
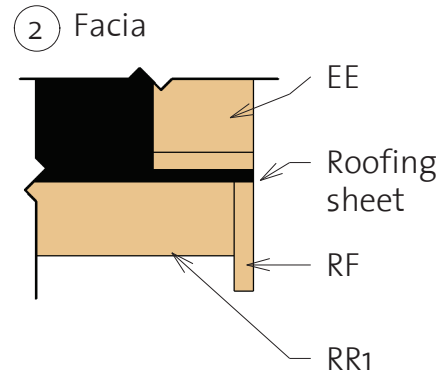
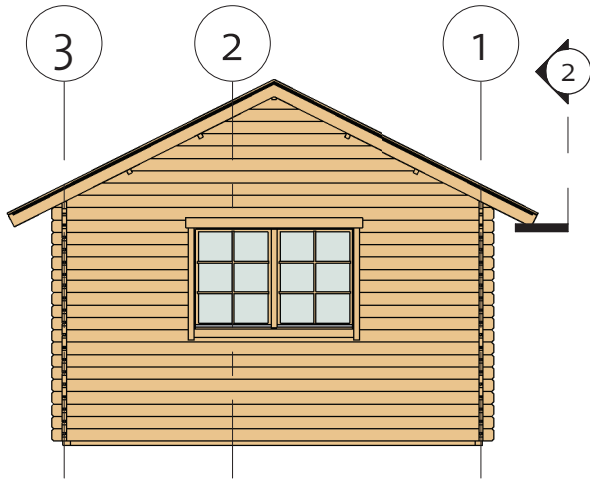

Fascia Schedule				
Mark	Type	Profile	Count	Length
EE	Eave Edging 18x95		4	2740
RF	Roof Fascia 18x120		4	2740
RR1	Roof reinforcement 18x120		4	3375
RR2	Roof reinforcement 38x38		4	3375

# Caroline Lofted 40 (575x390)

Stair

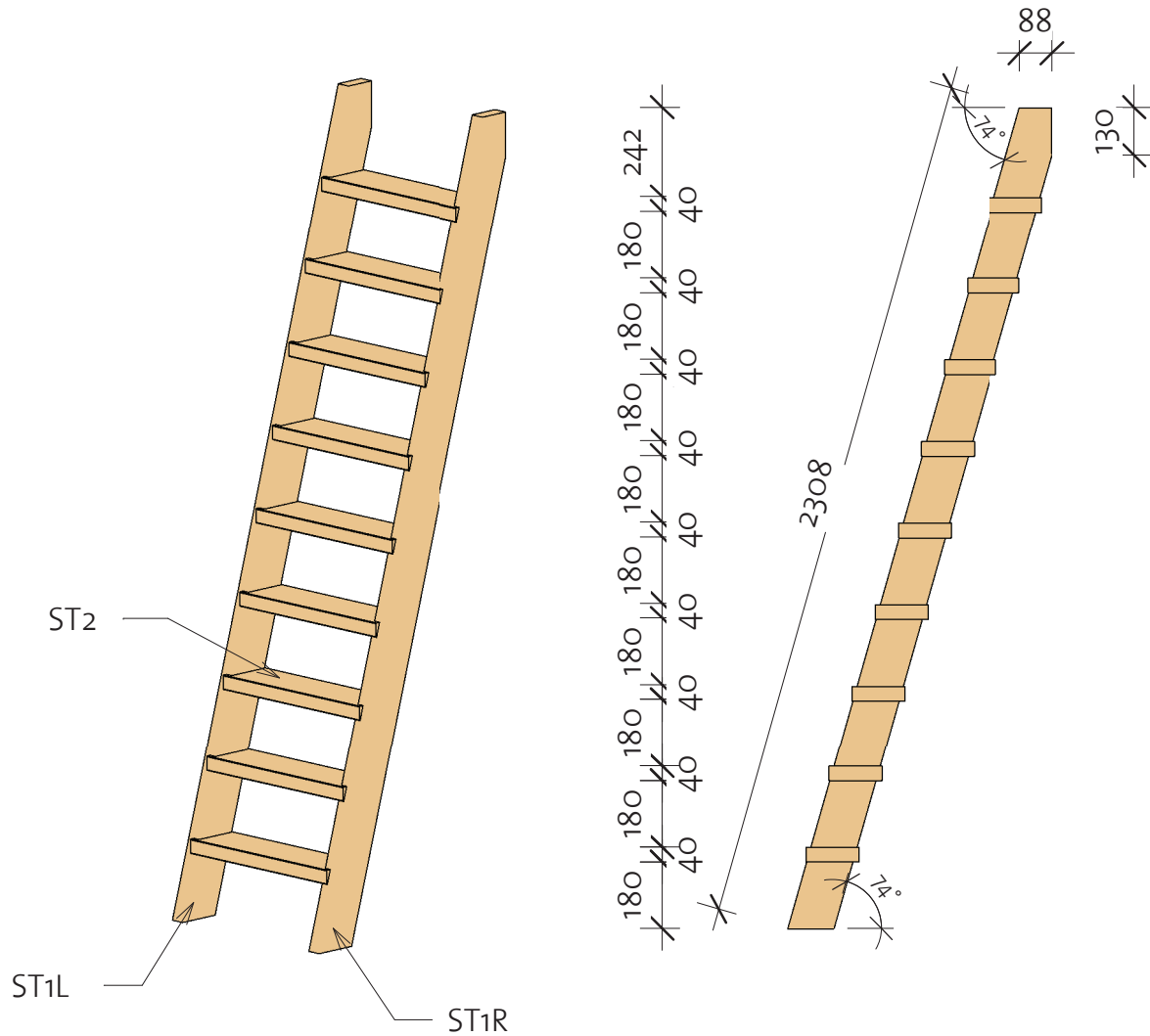

Stair				
Mark	Profile	Profile	Count	Cut Length
ST1L	Stair 40X120		1	2333
ST1R	Stair 40X120		1	2333
ST2	Stair 40X143		9	520

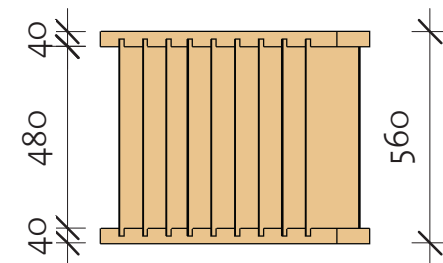

# Caroline Lofted 40 (575x390)

Extras



Door Schedule				
Mark	Type	Width	Height	Count
CD4R	Classic door 4 right	840	1955	1
CDD1R	Classic double door 1 right	1425	1955	1
DCB6	Door Crossbar 6	--	--	3
DB	Door beam 850 mm	40	12	1

Window Schedule				
Mark	Type	Width	Height	Count
CDW1	Classic double window 1	1530	990	1
CW1R	Classic window 1 right	765	990	1
CW12R	Classic window 12, full glass righth	540	540	1
WCB6	Windows Crossbar 6	--	--	3

Fasteners & Extras		
Name	Type	Count
Hitblock	300-400 mm	
Ladder fittings		2
Dowel	16,0 x 150	8
Bolts	M8 x 70	18
Screws	5,0 x 70	65
Screws	6,0 x 140	130
Nails	1,4 x 40	130
Screws	4,0 x 40	1500

Type	Count	Length
Windboard 18x40	4	2200
Windboard 18x40	2	2200

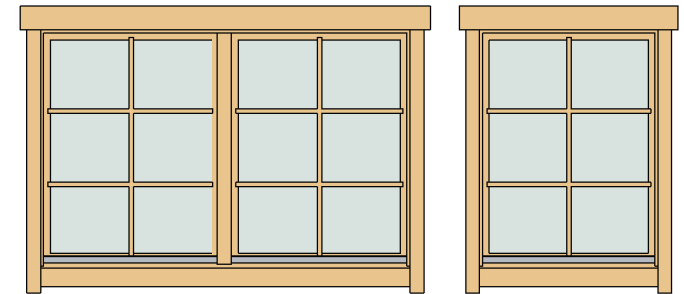

Family	Count
--------	-------

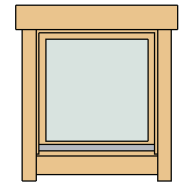

Romb	2
------	---





# Caroline Lofted 40 (575x390)

## List of all items 1



### Impregnated foundation beams

Mark	Type	Profile	Count	Length
IFB1	IFB 70x40		12	3750
IFB2	IFB 70x40		2	3625
IFB3	IFB 70x40		2	2115





### Floor Schedule

Mark	Type	Profile	Count	Length
FB1	FB 17x114		60	2054
FB2	FB 17x114		36	3564
FB3	FB 17x114		9	2097
BB1	BB 20x40		9	3900
BB2	BB 20x40		4	2200

### Second floor

Mark	Type	Profile	Count	Cut Length
CB1	40x90		2	1520
CB2	40x90		2	2260
CB3	Ceiling beam 40x143		3	4100

### Fascia Schedule

Mark	Type	Profile	Count	Length
EE	Eave Edging 18x95		4	2740
RF	Roof Fascia 18x120		4	2740
RR1	Roof reinforcement 18x120		4	3375
RR2	Roof reinforcement 38x38		4	3375

# Caroline Lofted 40 (575x390)

## List of all items 2

Wall 1			
Mark	Profile	Count	Cut Length



1BL-1	40X57	1	1205
1BL-2	40X57	1	3305
1LG-1	40X114	9	785
1LG-2	40X114	17	1205
1LG-3	40X114	9	1750
1LG-4	40X114	1	2420
1LG-5	40X114	8	3305
1LG-6	40X114	1	3930
1LG-7	40X114	1	5950
1TL-1	40X123	1	2620
1TL-2	40X123	1	4130

Wall 2			
Mark	Profile	Count	Cut Length

2BL-1	40X57	1	2340
2LG-1	40X114	18	2340
2TL-1	40X114	1	2340

\* Gable - delivered premounted

Log Profiles 1	
Profile	Profile

40X57	
40X114	

Wall 3			
Mark	Profile	Count	Cut Length

3BL-1	40X57	1	5950
3LG-1	40X114	1	2420
3LG-2	40X114	1	3930
3LG-3	40X114	17	5950
3LG-4	40X114	1	5950
3TL-1	40X123	1	2620
3TL-2	40X123	1	4130

Wall A			
Mark	Profile	Count	Cut Length

ALG-1 *	40X114	1	455
ALG-2 *	40X114	1	908
ALG-3	40X114	18	1280
ALG-4 *	40X114	1	1362
ALG-5 *	40X114	1	1815
ALG-6 *	40X114	1	2269
ALG-7 *	40X114	1	2722
ALG-8 *	40X114	1	3176
ALG-9 *	40X114	1	3629
ALG-10 *	40X114	1	4068
ALG-11 *	40X114	1	4100
ALG-12	40X114	10	4100

Log Profiles 1	
Profile	Profile

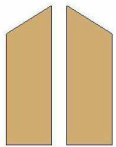
40X114	
40X123	

# Caroline Lofted 40 (575x390)

## List of all items 3

Wall B			
Mark	Profile	Count	Cut Length



BLG-1	40X114	34	240
BLG-2 *	40X114	1	1360
BLG-3 *	40X114	1	455
BLG-4 *	40X114	2	583
BLG-5 *	40X114	2	809
BLG-6 *	40X114	1	908
BLG-7 *	40X114	2	1008
BLG-8 *	40X114	2	1263
BLG-9 *	40X114	2	1490
BLG-10*	40X114	2	1709
BLG-11	40X114	17	1920
BLG-12*	40X114	1	4100
BLG-13	40X114	1	4100
BLG-14	40X114	1	4100

Wall C			
Mark	Profile	Count	Cut Length

CLG-1 *	40X114	1	455
CLG-2 *	40X114	2	635
CLG-3 *	40X114	2	862
CLG-4 *	40X114	1	908
CLG-5 *	40X114	2	1061
CLG-6*	40X114	2	1315
CLG-7 *	40X114	1	1360
CLG-8*	40X114	2	1542
CLG-9*	40X114	1	4068
CLG-10*	40X114	1	4100
CLG-11	40X114	19	4100

\* Gable - delivered premounted

Roof				
Mark	Type	Profile	Count	Length

RB	17X114		120	2690
RFB1	Beam 40X143		4	2840
RFB2	Beam 40X143		4	4350
RFB3	Ridge 40X120		1	520
RFR1	Ridge 40X143		1	2620
RFR2	Ridge 40X143		1	4130



Log Profiles 2	
Profile	Profile

40X114	
--------	---



# Caroline Lofted 40 (575x390)

## List of all items 4

Stair				
Mark	Profile	Profile	Count	Cut Length
ST1L	Stair 40x120		1	2333
ST1R	Stair 40x120		1	2333
ST2	Stair 143x40		9	520