

Denver 3 1 1/8" (108 1/4"x108 1/4")

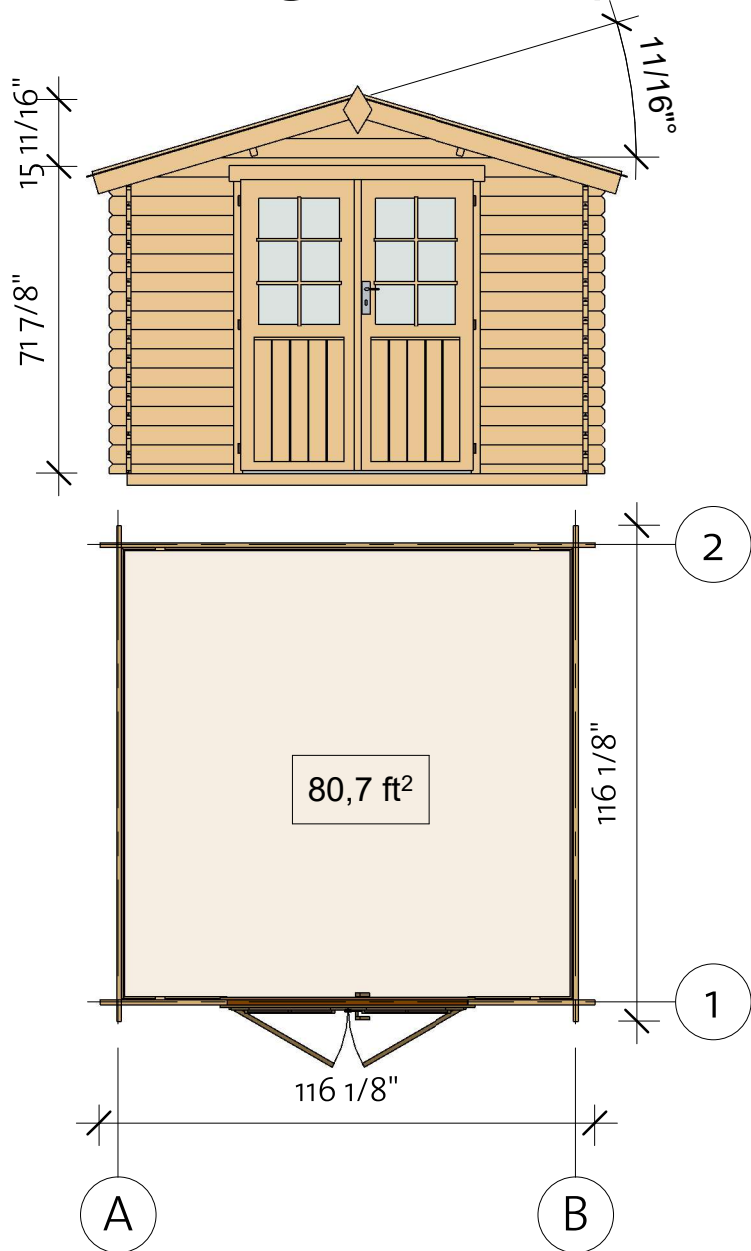

190418

Denver 3 1 1/8" (108 1/4"x108 1/4")

Foundation

Impregnated foundation beams				
Mark	Type	Profile	Count	Length

IFB	IFB 40x70		6	107 7/8"
-----	--------------	---	---	-------------

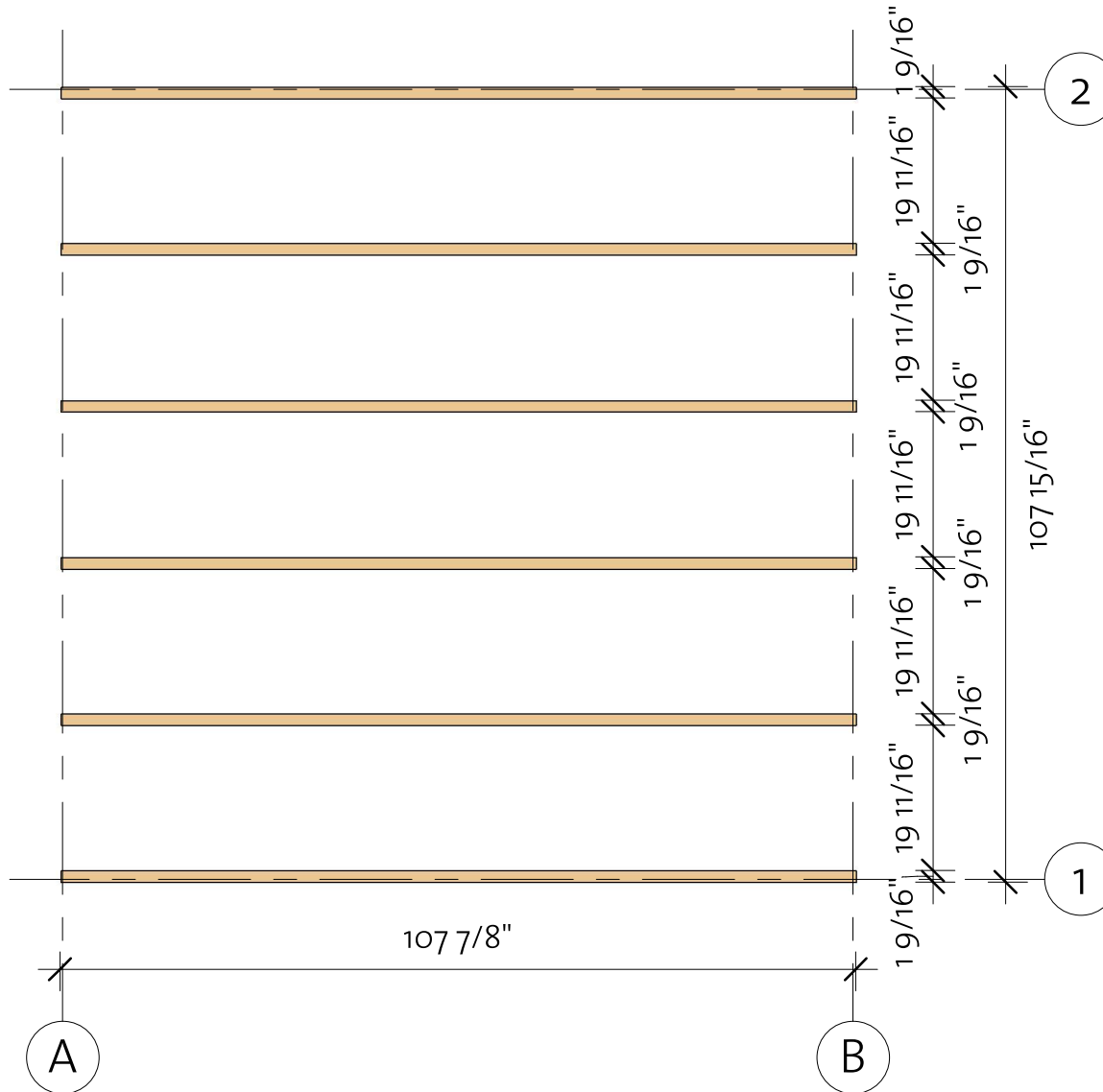



Denver 3 1 1/8" (108 1/4" x 108 1/4")

Floor Plan

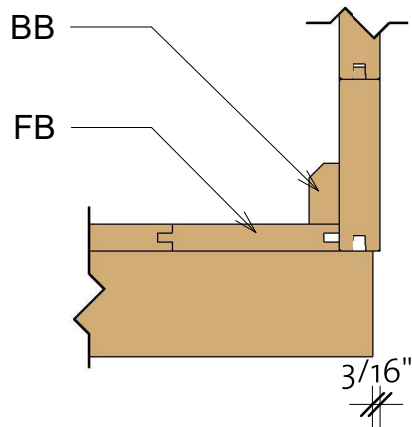
① Baseboard



Floor Schedule				
Mark	Type	Profile	Count	Length
FB	FB 18x110		26	105 7/8"
BB	BB 20x40		4	108 1/4"

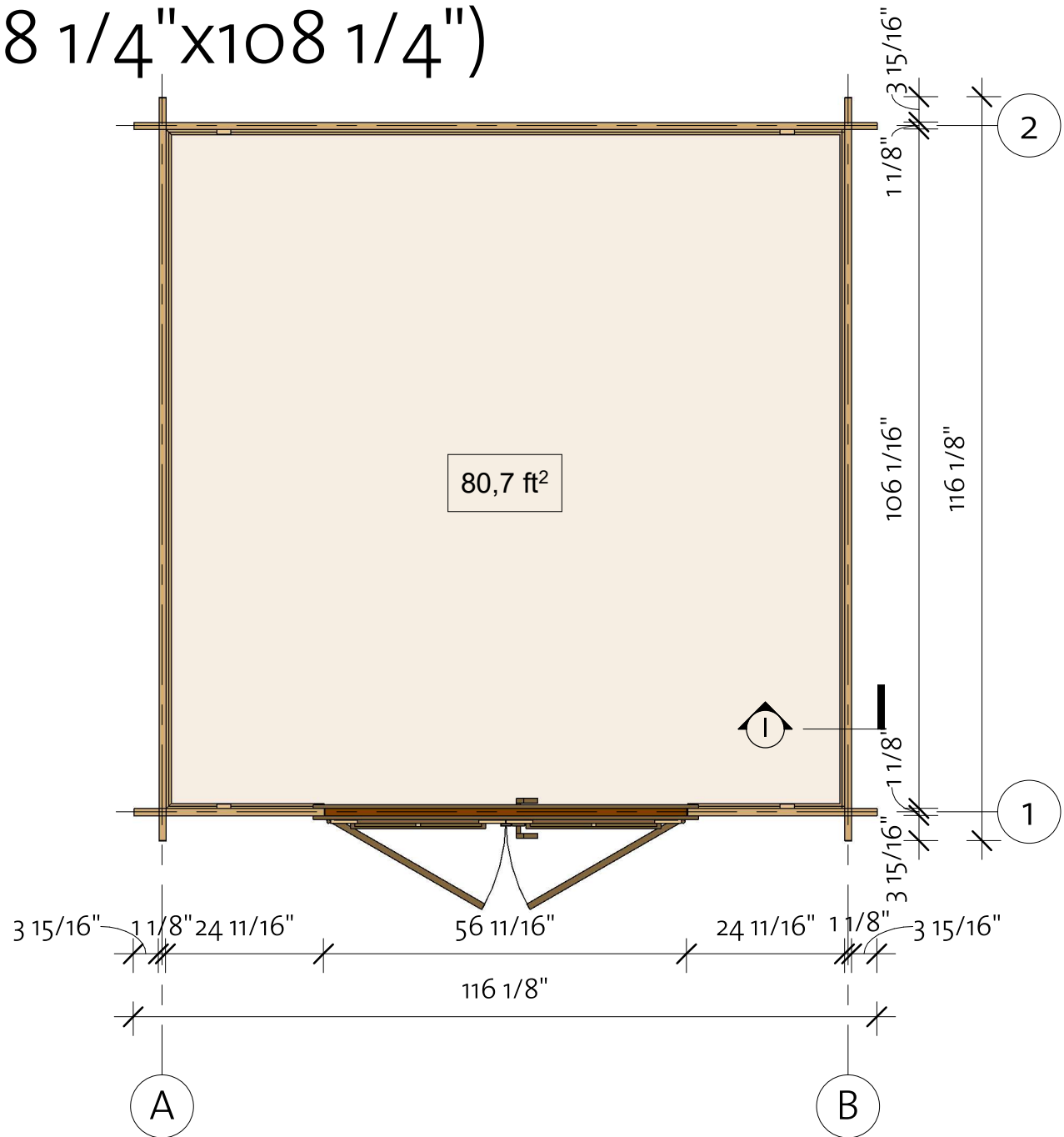

Denver 3 1 1/8" (108 1/4"x108 1/4")

Wall 1



Wall 1			
Mark	Profile	Count	Cut Length

1BL 1	28x57	2	29 13/16"
1LG 1	28x114	30	29 13/16"
1LG 2*	28x114	1	30 7/16"
1LG 3*	28x114	1	60 3/4"
1LG 4*	28x114	1	91 1/16"
1LG 5*	28x114	1	116 1/8"

* Gable - delivered premounted

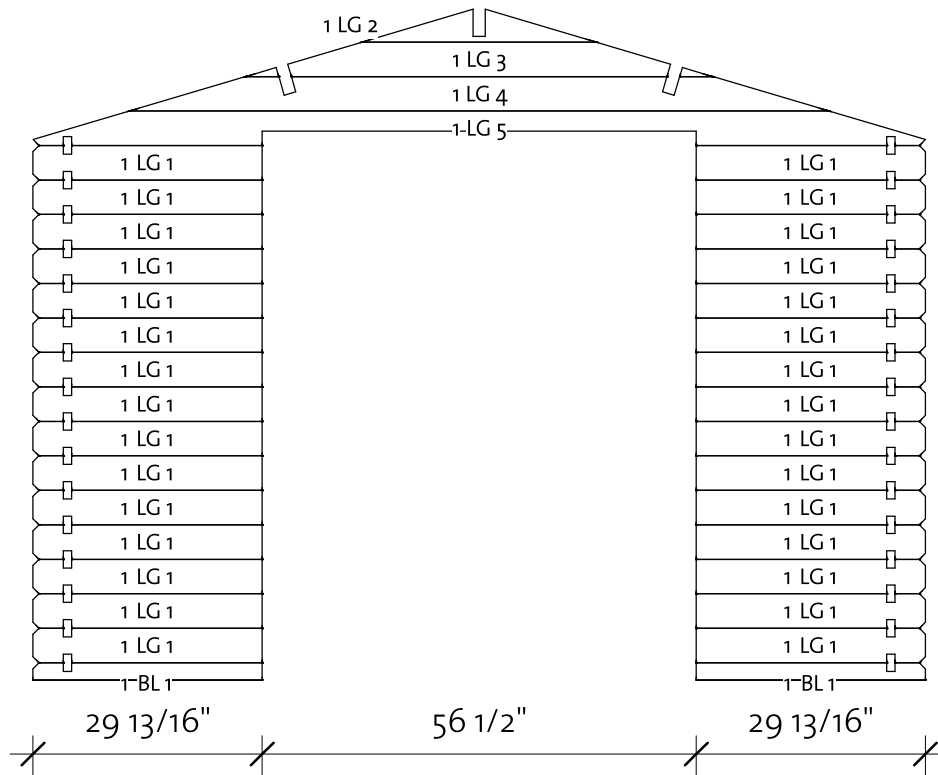

Log Profile Wall 1	
Profile	Profile

28x57	
28x114	

Denver 3 1 1/8" (108 1/4"x108 1/4")

Wall 2

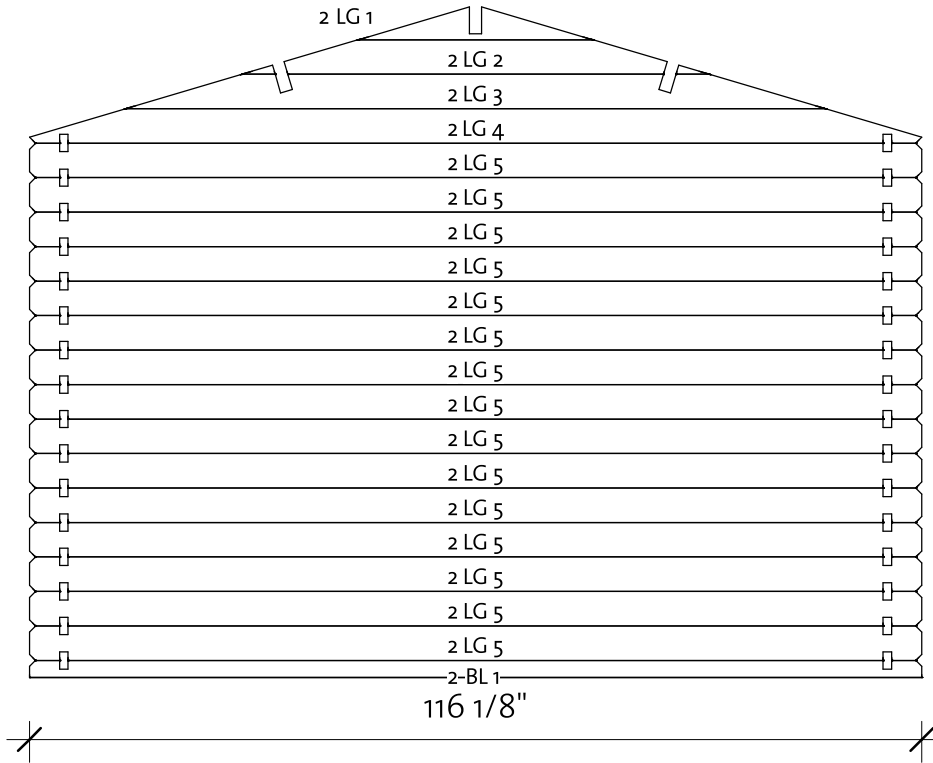
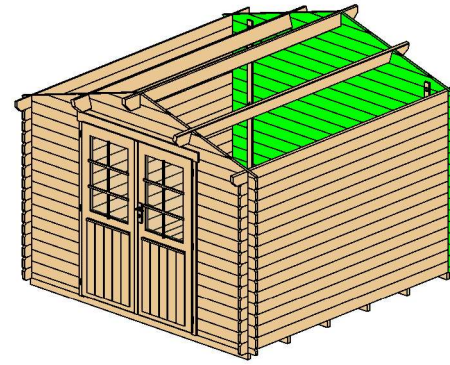

Wall 2			
Mark	Profile	Count	Cut Length

2BL 1	28x57	1	116 1/8"
2LG 1*	28x114	1	30 7/16"
2LG 2*	28x114	1	60 3/4"
2LG 3*	28x114	1	91 1/16"
2LG 4*	28x114	1	116 1/8"
2LG 5	28x114	15	116 1/8"

* Gable - delivered premounted

Log Profile Wall 2	
Profile	Profile

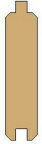
28x57	
28x114	

Denver 3 1 1/8" (108 1/4"x108 1/4")

Wall A



Wall A			
Mark	Profile	Count	Cut Length

ALG 1	28x114	15	116 1/8"
ATL 1	28x115	1	124"

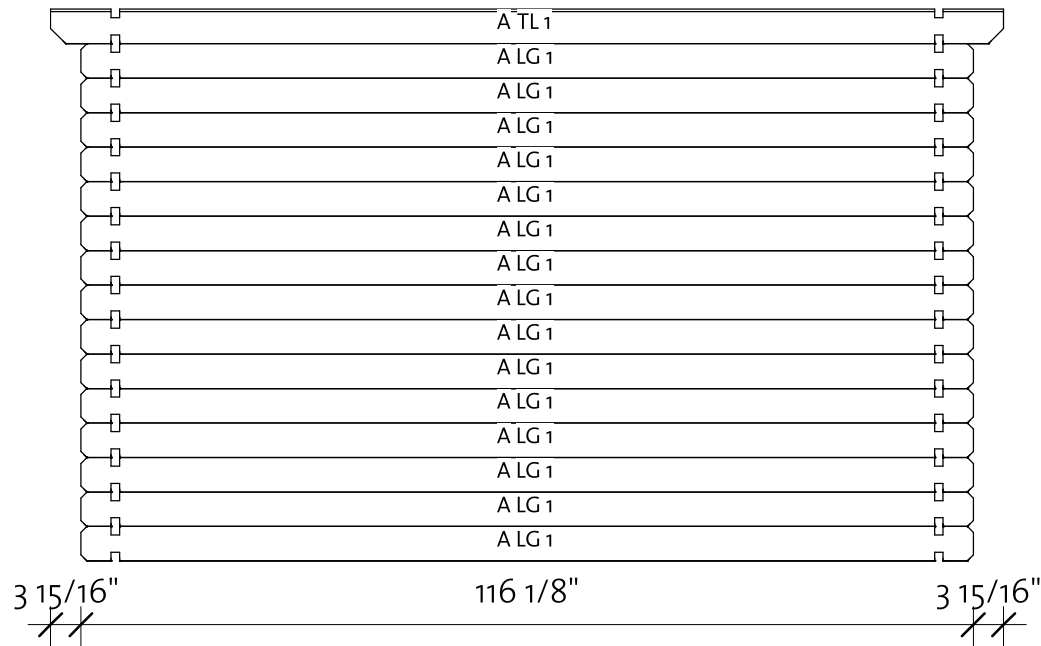

Log Profile Wall A	
Profile	Profile

28x114	
28x115	

Denver 3 1 1/8" (108 1/4"x108 1/4")

Wall B

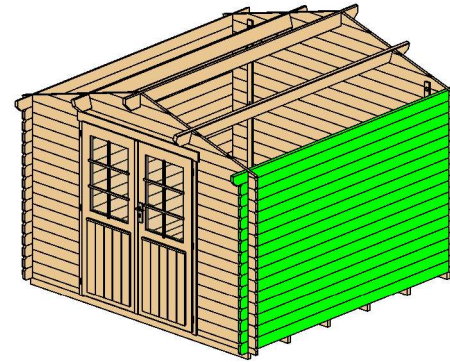

Wall B			
Mark	Profile	Count	Cut Length

BLG 1	28x114	15	116 1/8"
BTL 1	28x115	1	124"

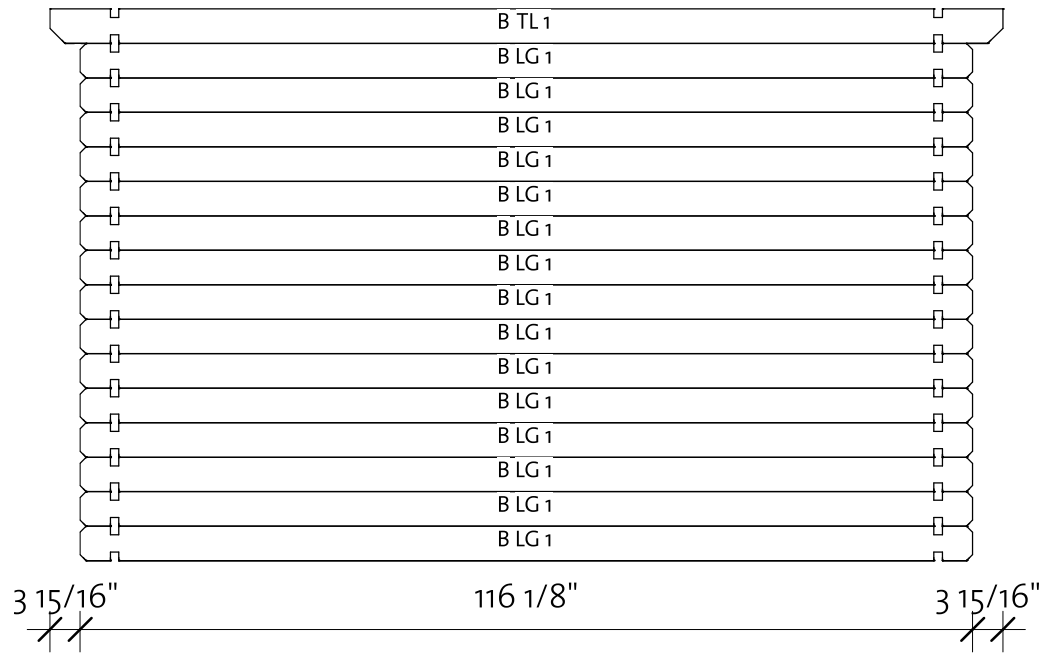





Log Profile Wall B	
Profile	Profile

28x114	
28x115	

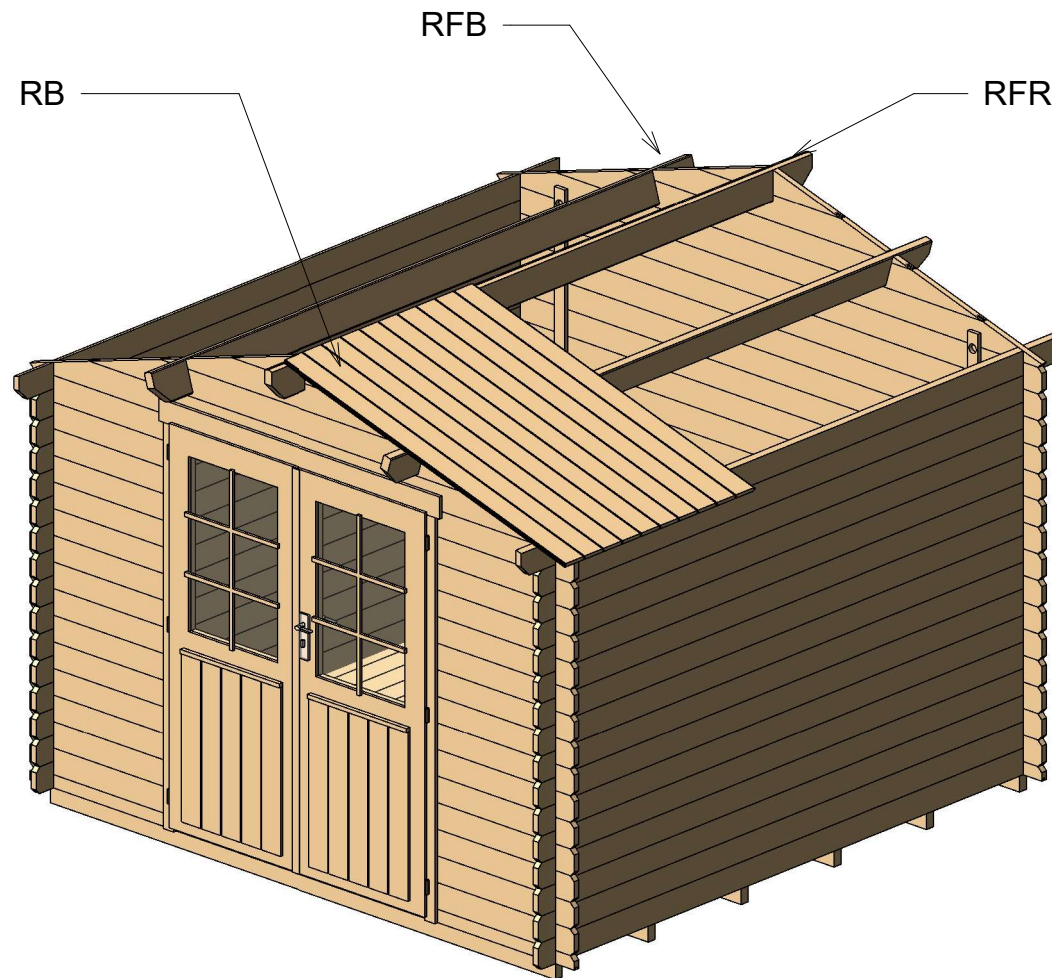
Denver 3 1 1/8" (108 1/4"x108 1/4")

Roof 1



Roof				
Mark	Type	Profile	Count	Length
RFR	Ridge 40x143		1	124"
RFB	Beam 40x143		2	124"
RB	Roofboard 18x110		60	62 5/8"

Denver 3 1 1/8" (108 1/4"x108 1/4")

Roof 2

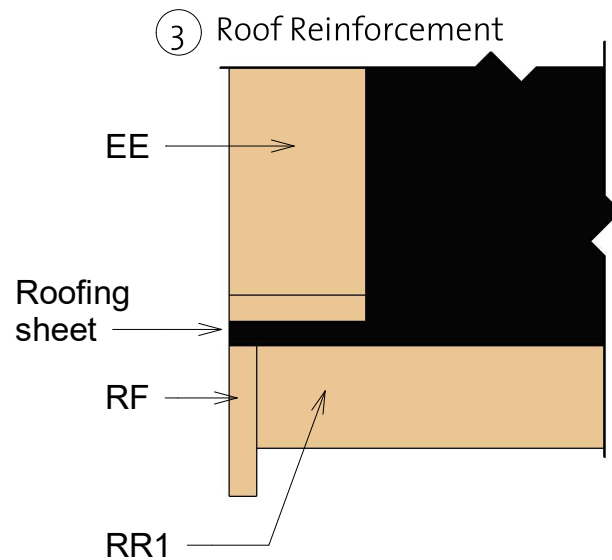
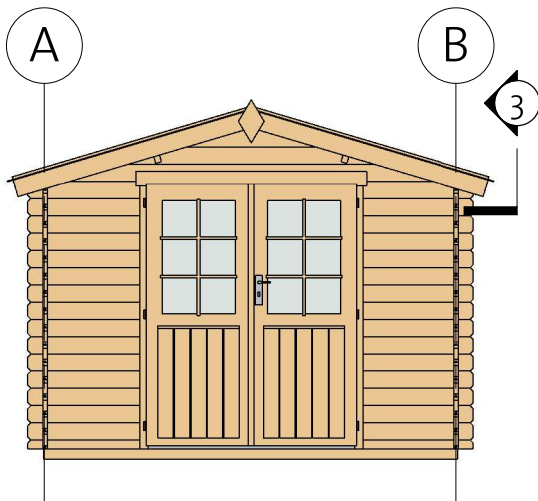
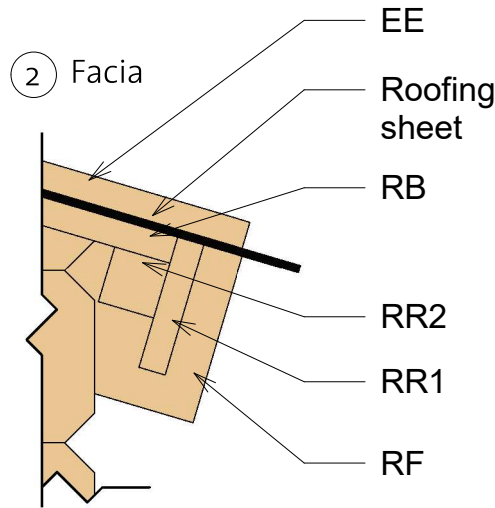
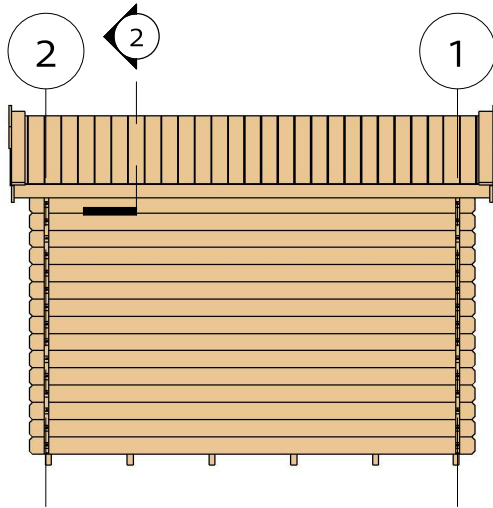

Fascia Schedule				
Mark	Type	Profile	Count	Length

EE	Eave Edging 18x90		4	64 9/16"
RF	Roof Fascia 18x115		4	64 9/16"
RR1	Roof reinforcement 18x90		2	124"
RR2	Roof reinforcement 38x38		2	124"

Denver 3 1 1/8" (108 1/4"x108 1/4")

Extras

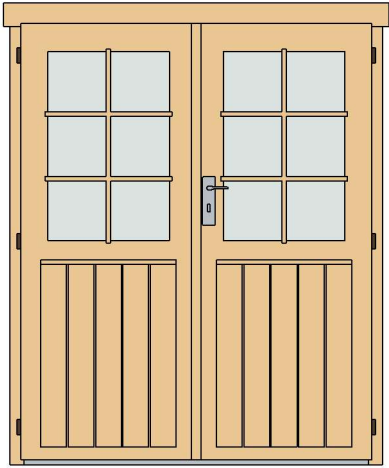

Door Schedule				
Model	Type	Width	Height	Count
BDD3R	Basic double door 3 right	56 1/8"	69 7/8"	1
DCB6	Door crossbar 6	--	--	2



Type	Count	Lenght
Windboard 18x40	4	86 5/8"

Fasteners/Extras		
Name	Type	Count



Family	Count
Romb	2

Hitblock	11 13/16"-15 3/4"	
Screws	3/16" x 2 3/4"	10
Bolts	M5/16" x 2 3/8"	12
Screws	1/4" x 5 1/2"	30
Nails	1/16" x 1 9/16"	30
Screws	3/16" x 1 9/16"	55
Screws	3/16" x 2"	370



Denver 3 1 1/8" (108 1/4"x108 1/4")

List of all items 1



Impregnated foundation beams				
Mark	Type	Profile	Count	Length

IFB	IFB 40x70		6	107 7/8"
-----	--------------	---	---	-------------





Floor Schedule				
Mark	Type	Profile	Count	Length

FB	FB 18x110		26	105 7/8"
BB	BB 20x40		4	108 1/4"

Roof				
Mark	Type	Profile	Count	Length

RFR	Ridge 40x143		1	124"
RFB	Beam 40x143		2	124"
RB	Roofboard 18x110		60	62 5/8"

Fascia Schedule				
Mark	Type	Profile	Count	Length

EE	Eave Edging 18x90		4	64 9/16"
RF	Roof Fascia 18x115		4	64 9/16"
RR1	Roof reinforcement 18x90		2	124"
RR2	Roof reinforcement 38x38		2	124"

Denver 3 1 1/8" (108 1/4"x108 1/4")

List of all items 2

Wall 1			
Mark	Profile	Count	Cut Length

1BL 1	28x57	2	29 13/16"
1LG 1	28x114	30	29 13/16"
1LG 2*	28x114	1	30 7/16"
1LG 3*	28x114	1	60 3/4"
1LG 4*	28x114	1	91 1/16"
1LG 5*	28x114	1	116 1/8"

Wall 2			
Mark	Profile	Count	Cut Length

2BL 1	28x57	1	116 1/8"
2LG 1*	28x114	1	30 7/16"
2LG 2*	28x114	1	60 3/4"
2LG 3*	28x114	1	91 1/16"
2LG 4*	28x114	1	116 1/8"
2LG 5	28x114	15	116 1/8"

Wall A			
Mark	Profile	Count	Cut Length



ALG 1	28x114	15	116 1/8"
ATL 1	28x115	1	124"

Wall B			
Mark	Profile	Count	Cut Length

BLG 1	28x114	15	116 1/8"
BTL 1	28x115	1	124"

* Gable - delivered premounted

Log Profiles	
Profile	Profile

28x57	
28x114	

Log Profiles	
Profile	Profile

28x115	
--------	---