

# Kiosk 1 1/8" (110 1/4" x 110 1/4")

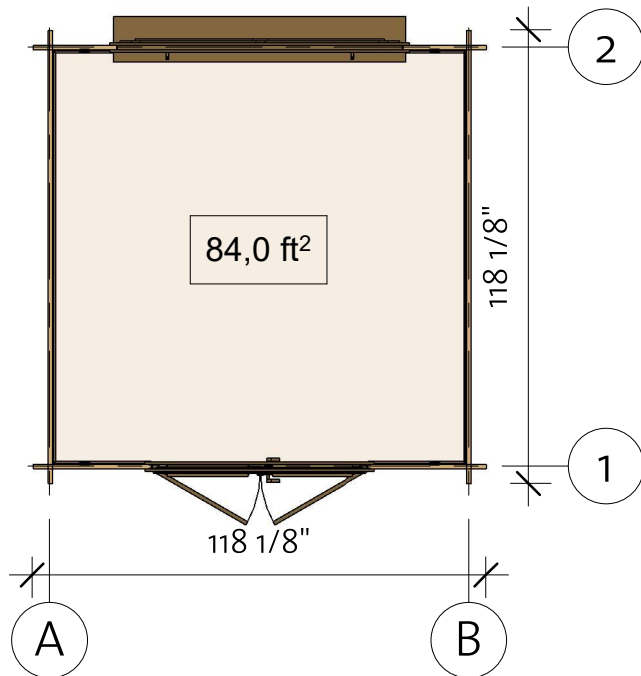
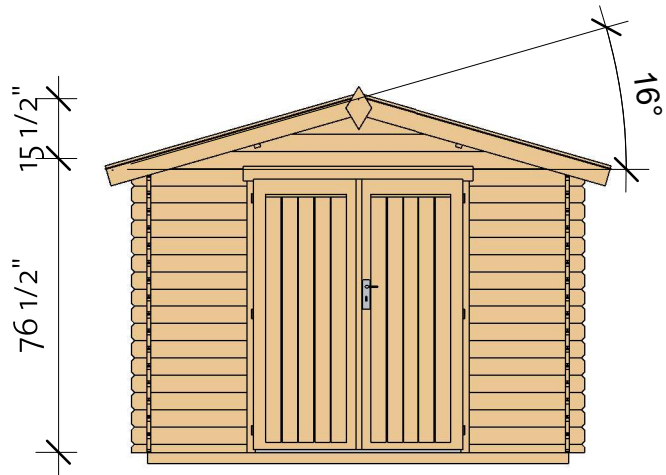

190423

# Kiosk 1 1/8" (110 1/4"x110 1/4")

Foundation

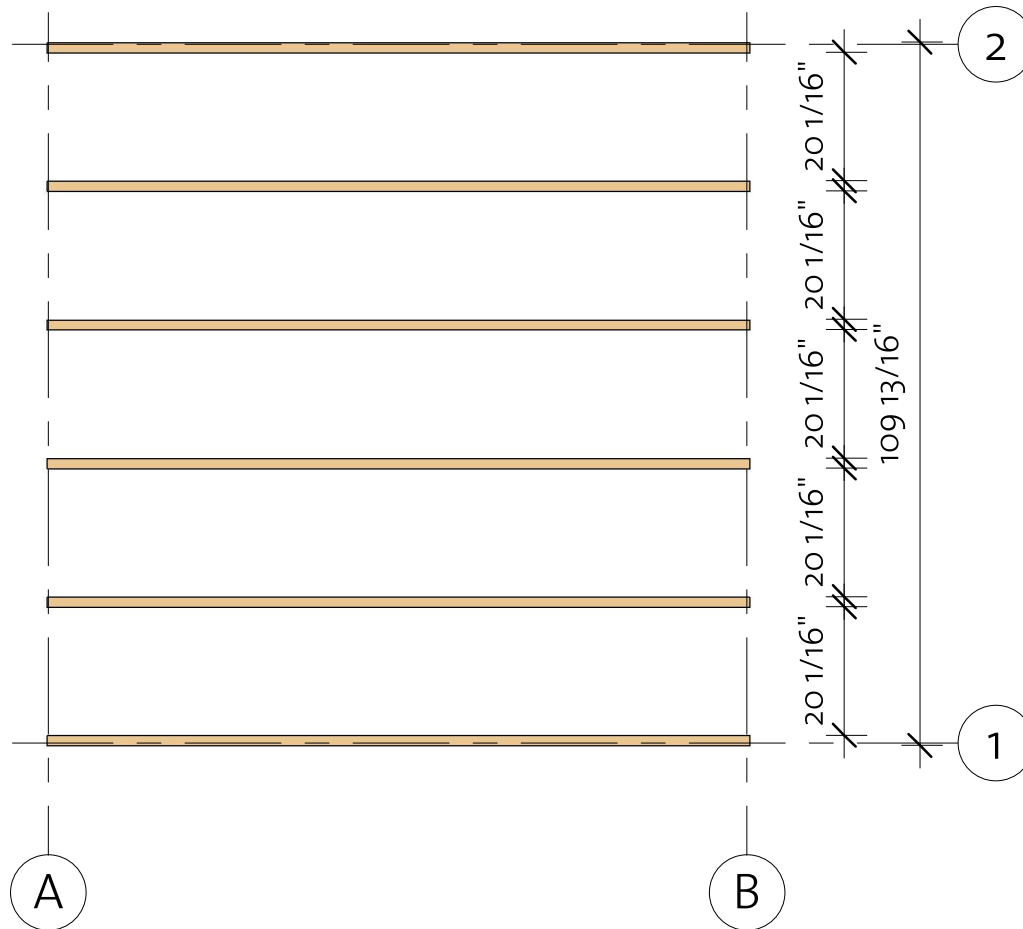

Impregnated foundation beams				
Mark	Type	Profile	Count	Length



IFB	IFB 40x70		6	109 13/16"
-----	--------------	---	---	---------------

# Kiosk 1 1/8" (110 1/4" x 110 1/4")

Floor Plan

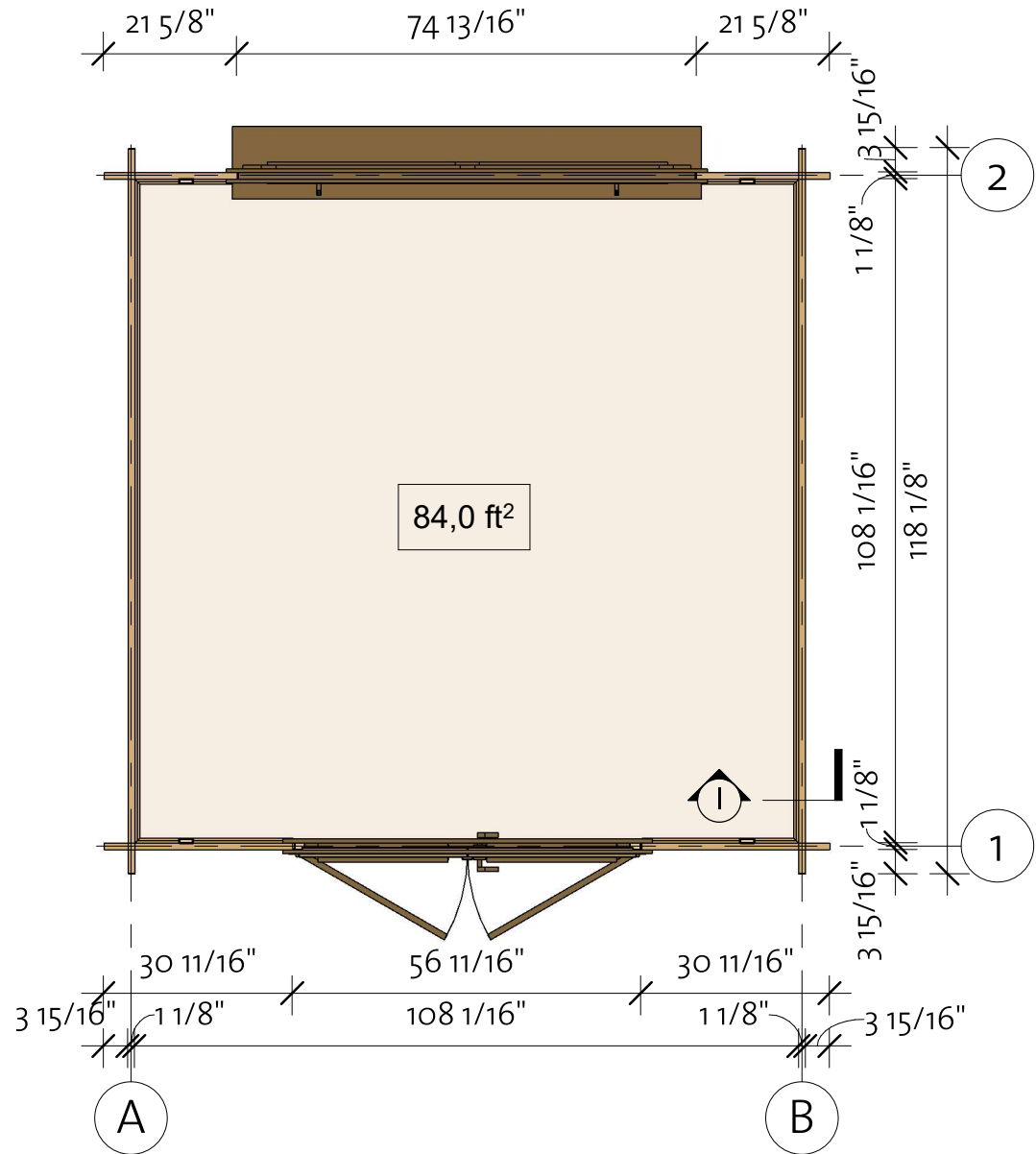
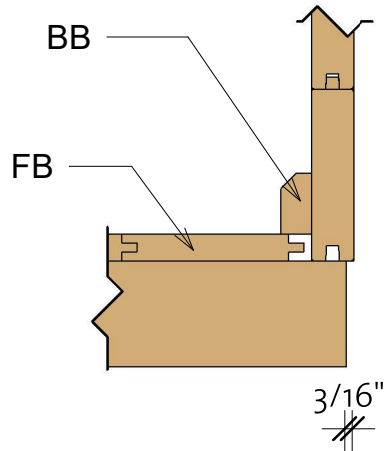
① Baseboard



Floor Schedule				
Mark	Type	Profile	Count	Length
FB	FB 18x110		26	107 7/8"
BB	BB 20x40		4	110 1/4"

# Kiosk 1 1/8" (110 1/4"x110 1/4")

Wall 1

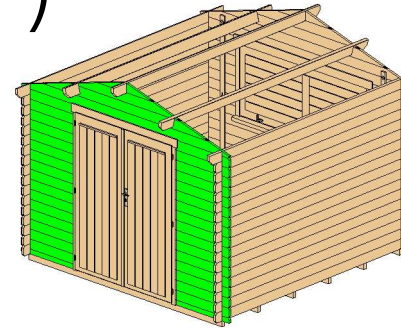

Wall 1			
Mark	Profile	Count	Cut Length

1BL 1	28x57	2	30 11/16"
1LG 1	28x114	32	30 11/16"
1LG 2*	28x114	1	31 1/4"
1LG 3*	28x114	1	62 1/2"
1LG 4*	28x114	1	93 13/16"
1LG 5*	28x114	1	118 1/8"

\*Gable-delivered premounted

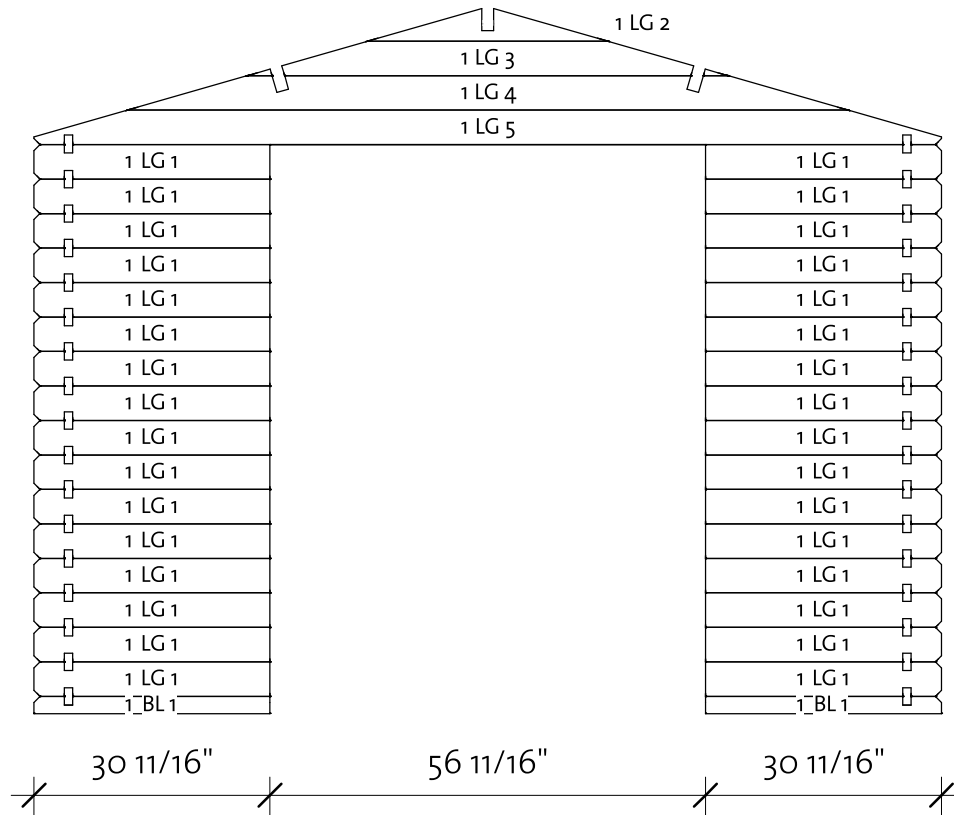

Log Profile Wall 1	
Profile	Profile

28x57	
28x114	

# Kiosk 1 1/8" (110 1/4"x110 1/4")

Wall 2

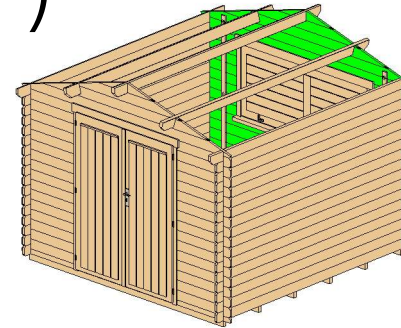

Wall 2			
Mark	Profile	Count	Cut Length

2BL 1	28x57	1	118 1/8"
2LG 1	28x114	16	21 5/8"
2LG 2*	28x114	1	31 1/4"
2LG 3*	28x114	1	62 1/2"
2LG 4*	28x114	1	93 13/16"
2LG 5*	28x114	1	118 1/8"
2LG 6	28x114	8	118 1/8"

\*Gable-delivered premounted

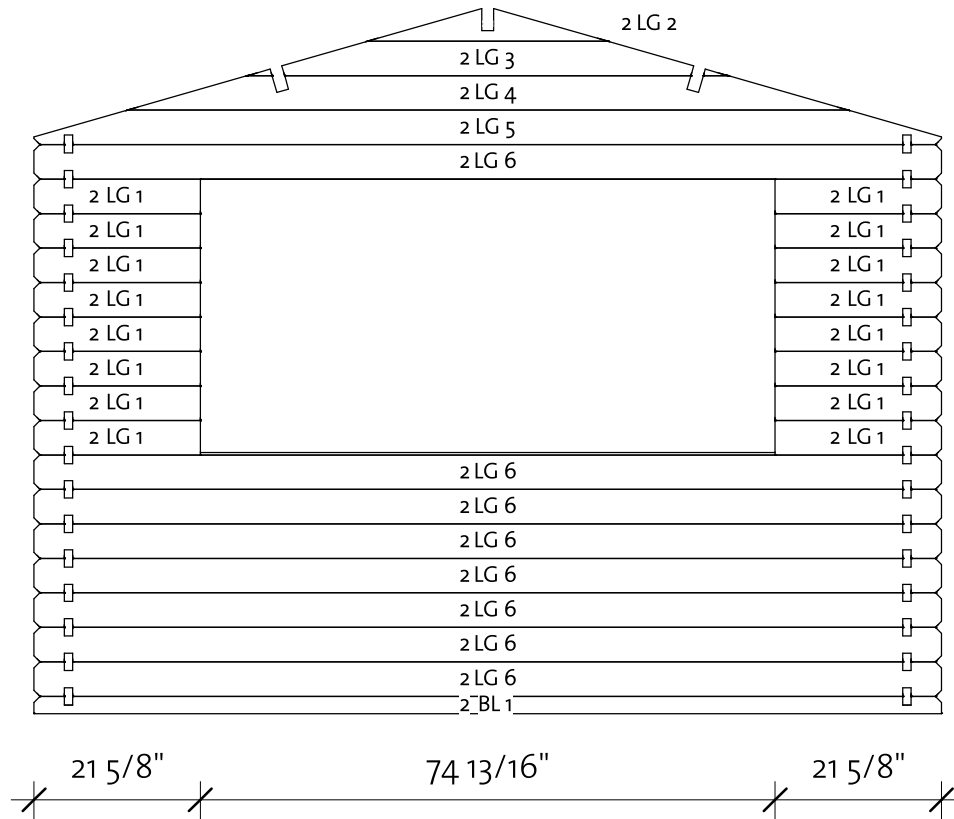

Log Profile Wall 2	
Profile	Profile

28x57	
28x114	

# Kiosk 1 1/8" (110 1/4"x110 1/4")

Wall A

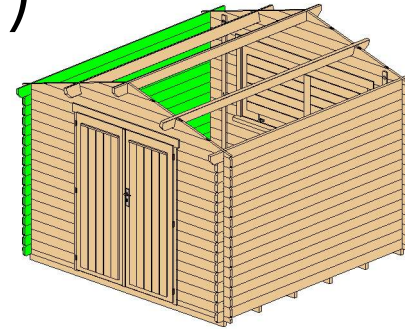

Wall A			
Mark	Profile	Count	Cut Length

ALG 1	28x114	16	118 1/8"
ATL 1	28x119	1	126"

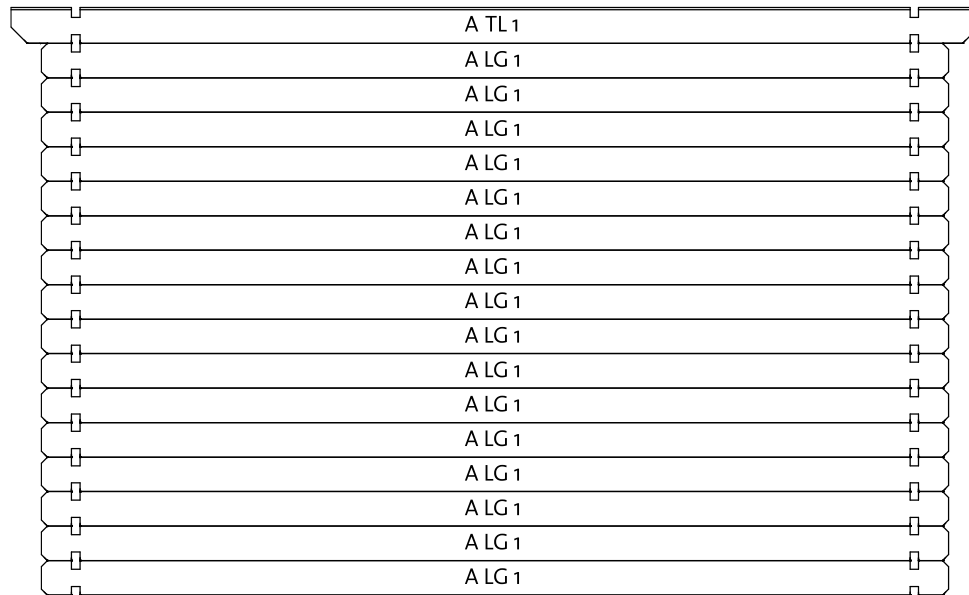

Log Profile Wall A	
Profile	Profile

28x114	
28x119	

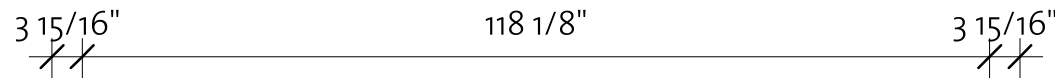

# Kiosk 1 1/8" (110 1/4"x110 1/4")

Wall B

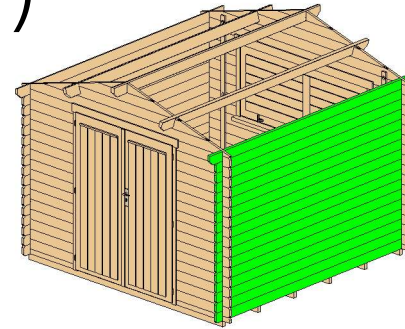

Wall B			
Mark	Profile	Count	Cut Length

BLG 1	28x114	16	118 1/8"
BTL 1	28x119	1	126"

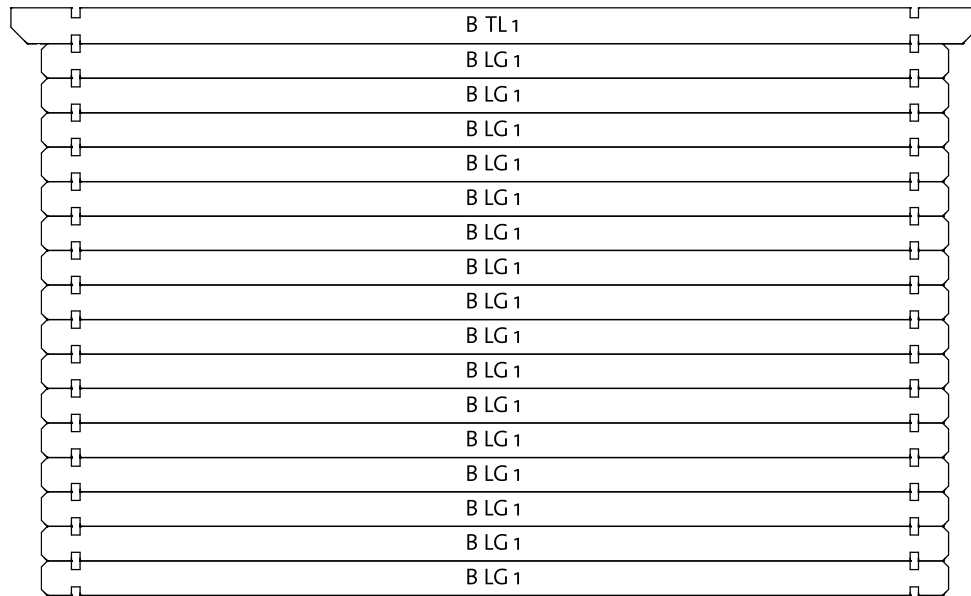

3 15/16"

118 1/8"

3 15/16"



Log Profile Wall B	
Profile	Profile

28x114	
28x119	

# Kiosk 1 1/8" (110 1/4"x110 1/4")

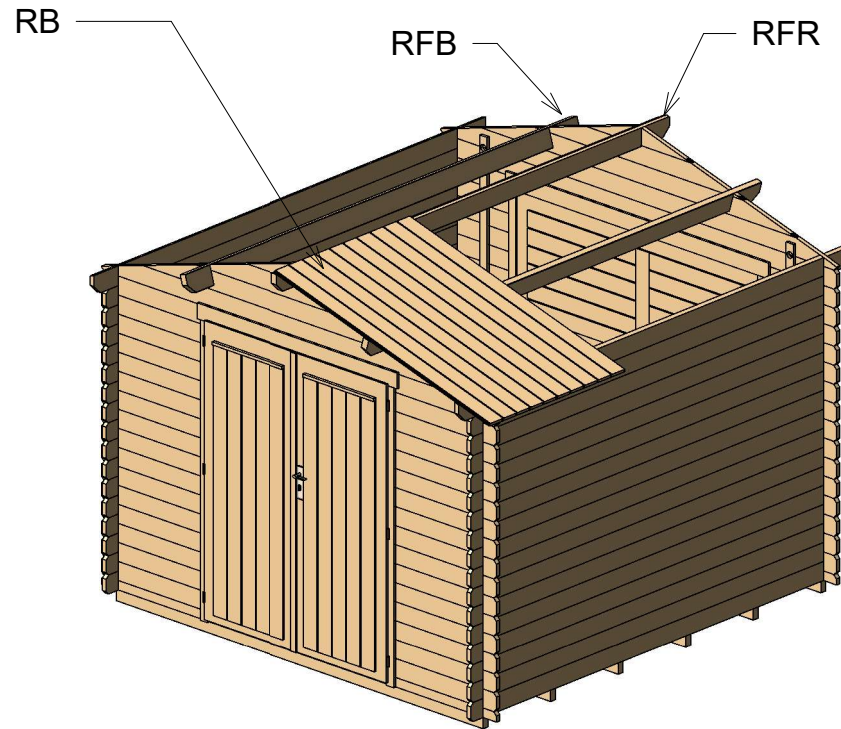
Roof 1



Roof				
Mark	Type	Profile	Count	Length
RFR	Ridge 40x120		1	126"
RFB	Beam 40x120		2	126"
RB	Roofboard 18x110		62	66 3/4"



# Kiosk 1 1/8" (110 1/4" x 110 1/4")

Roof 2

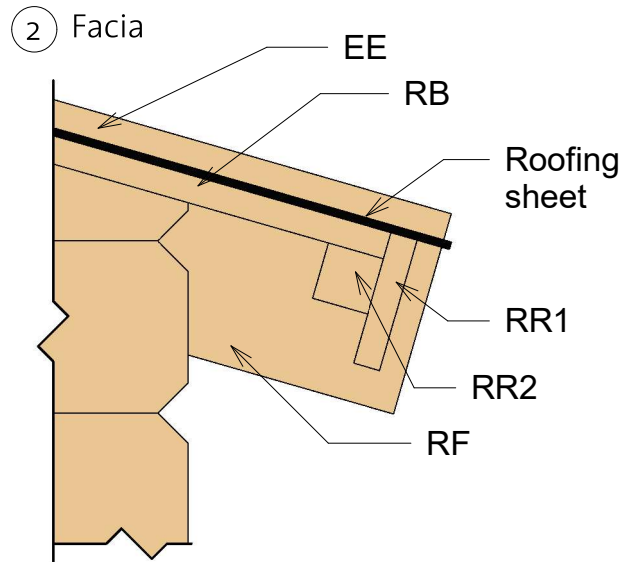
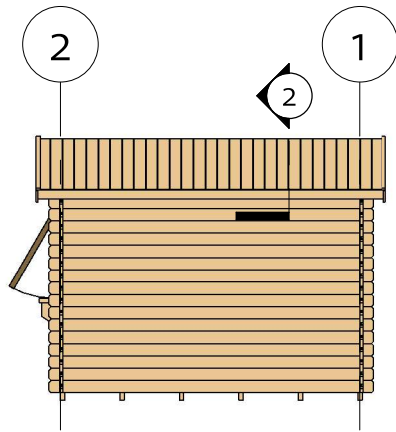

Fascia Schedule				
Mark	Type	Profile	Count	Length
EE	Eave Edging 18x40		4	68 5/16"
RF	Roof Fascia 18x115		4	68 5/16"
RR1	Roof reinforcement 18x90		2	126"
RR2	Roof reinforcement 38x38		2	126"

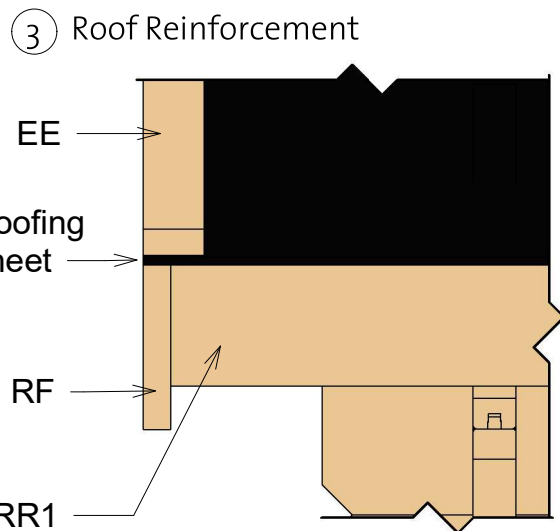
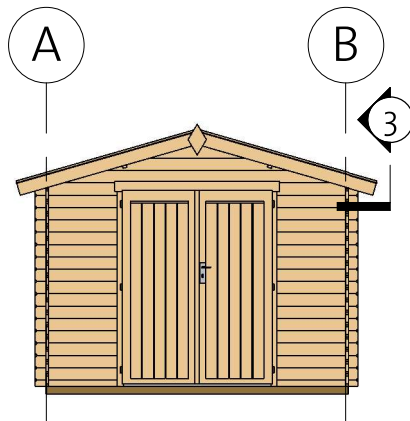

# Kiosk 1 1/8" (110 1/4" x 110 1/4")

Extras

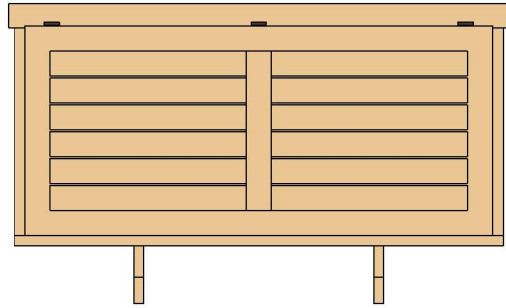
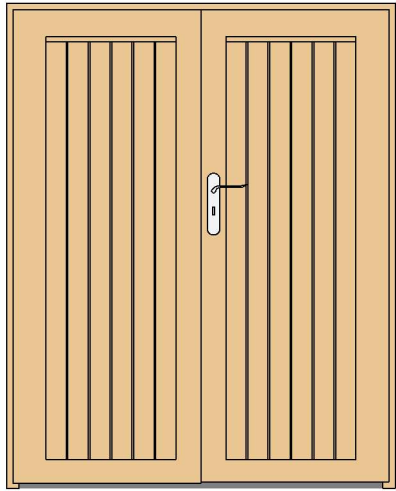

Schedule				
Model	Type	Width	Height	Count
BDD6R	Basic double door 6, wood right	56 1/8"	72 1/4"	1
KH1	Kiosk Hatch	74 7/16"	34 5/8"	1

Fasteners & Extras		
Name	Type	Count

Hitblock	11 13/16"-15 3/4"	
Bolts	M5/16" x 2 3/8"	12
Screws	3/16" x 2 3/4"	20
Screws	1/4" x 5 1/2"	30
Nails	1/16" x 1 9/16"	30
Screws	3/16" x 1 9/16"	90
Screws	3/16" x 2"	475



Type	Count	Length
------	-------	--------

Windboard 18x40	4	86 5/8"
-----------------	---	---------



Family	Count
--------	-------

Romb	2
------	---

# Kiosk 1 1/8" (110 1/4"x110 1/4")

## List of all items 1

### Impregnated foundation beams

Mark	Type	Profile	Count	Length
------	------	---------	-------	--------

IFB	IFB 40x70		6	109 13/16"
-----	--------------	---	---	---------------

### Floor Schedule



Mark	Type	Profile	Count	Length
------	------	---------	-------	--------

FB	FB 18x110		26	107 7/8"
----	-----------	---	----	-------------

BB	BB 20x40		4	110 1/4"
----	-------------	---	---	----------





### Roof

Mark	Type	Profile	Count	Length
------	------	---------	-------	--------

RFR	Ridge 40x120		1	126"
RFB	Beam 40x120		2	126"
RB	Roofboard 18x110		62	66 3/4"

### Fascia Schedule

Mark	Type	Profile	Count	Length
------	------	---------	-------	--------

EE	Eave Edging 18x40		4	68 5/16"
RF	Roof Fascia 18x115		4	68 5/16"
RR1	Roof reinforcement 18x90		2	126"
RR2	Roof reinforcement 38x38		2	126"

# Kiosk 1 1/8" (110 1/4"x110 1/4")

## List of all items 2

Wall 1			
Mark	Profile	Count	Cut Length

1BL 1	28x57	2	30 11/16"
1LG 1	28x114	32	30 11/16"
1LG 2*	28x114	1	31 1/4"
1LG 3*	28x114	1	62 1/2"
1LG 4*	28x114	1	93 13/16"
1LG 5*	28x114	1	118 1/8"

Wall 2			
Mark	Profile	Count	Cut Length

2BL 1	28x57	1	118 1/8"
2LG 1	28x114	16	21 5/8"
2LG 2*	28x114	1	31 1/4"
2LG 3*	28x114	1	62 1/2"
2LG 4*	28x114	1	93 13/16"
2LG 5*	28x114	1	118 1/8"
2LG 6	28x114	8	118 1/8"

\*Gable-delivered premounted



Wall A			
Mark	Profile	Count	Cut Length

ALG 1	28x114	16	118 1/8"
ATL 1	28x119	1	126"

Wall B			
Mark	Profile	Count	Cut Length

BLG 1	28x114	16	118 1/8"
BTL 1	28x119	1	126"

Log Profiles	
Profile	Profile

28x57	
28x114	
28x119	