

Kiosk 28 (280x280)

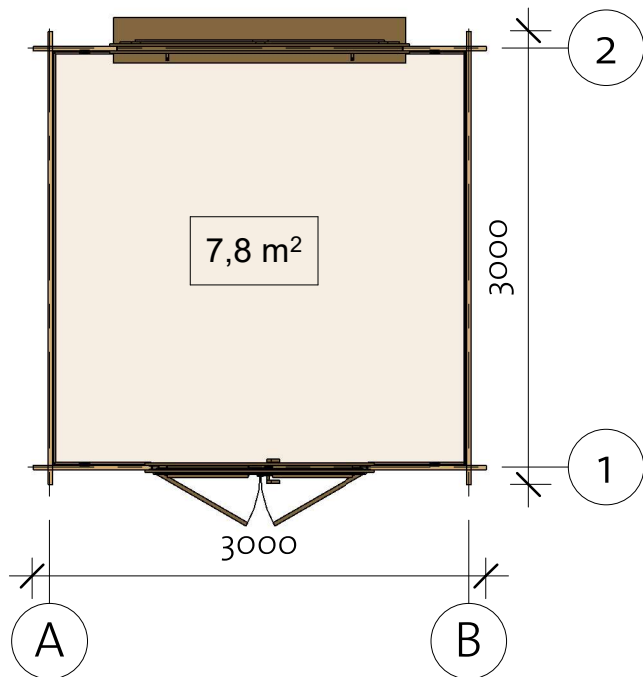
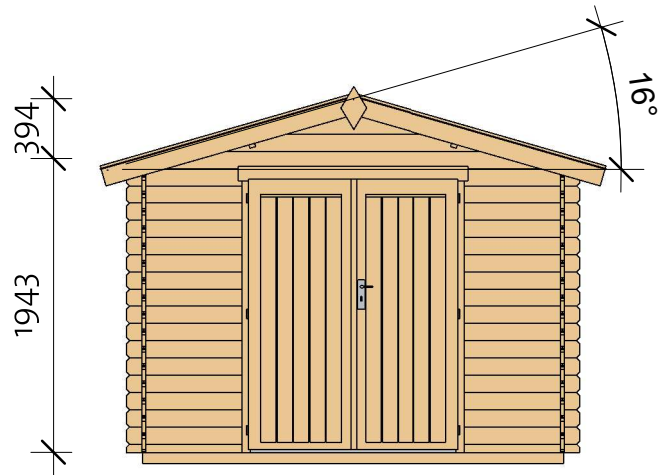

190423

Kiosk 28 (280x280)

Foundation

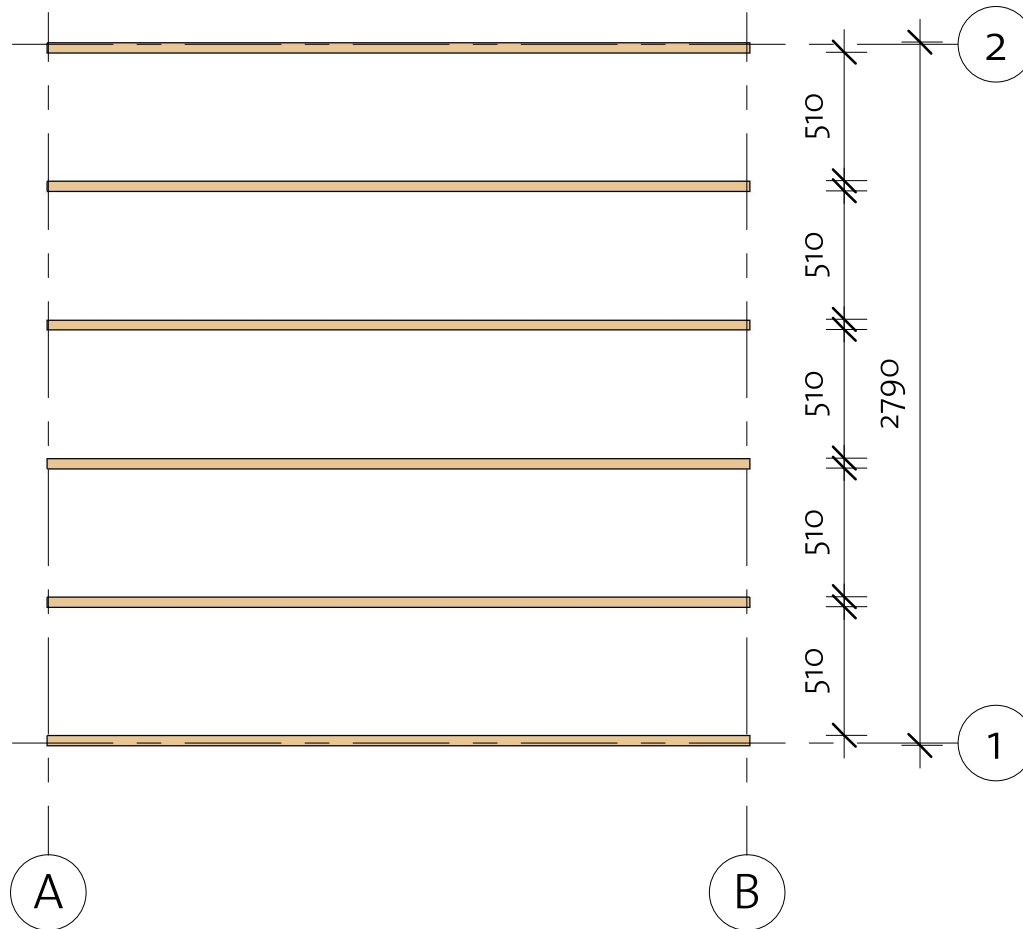

Impregnated foundation beams				
Mark	Type	Profile	Count	Length



IFB	IFB 40x70		6	2790
-----	--------------	---	---	------

Kiosk 28 (280x280)

Floor Plan

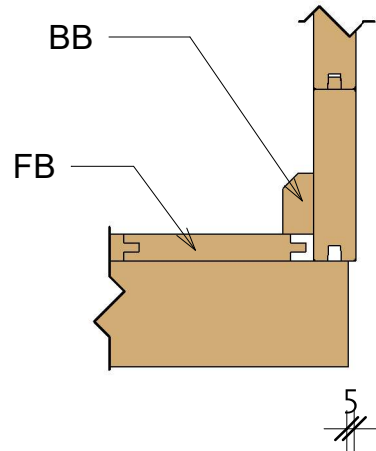
① Baseboard



Floor Schedule				
Mark	Type	Profile	Count	Length
FB	FB 18x110		26	2740
BB	BB 20x40		4	2800

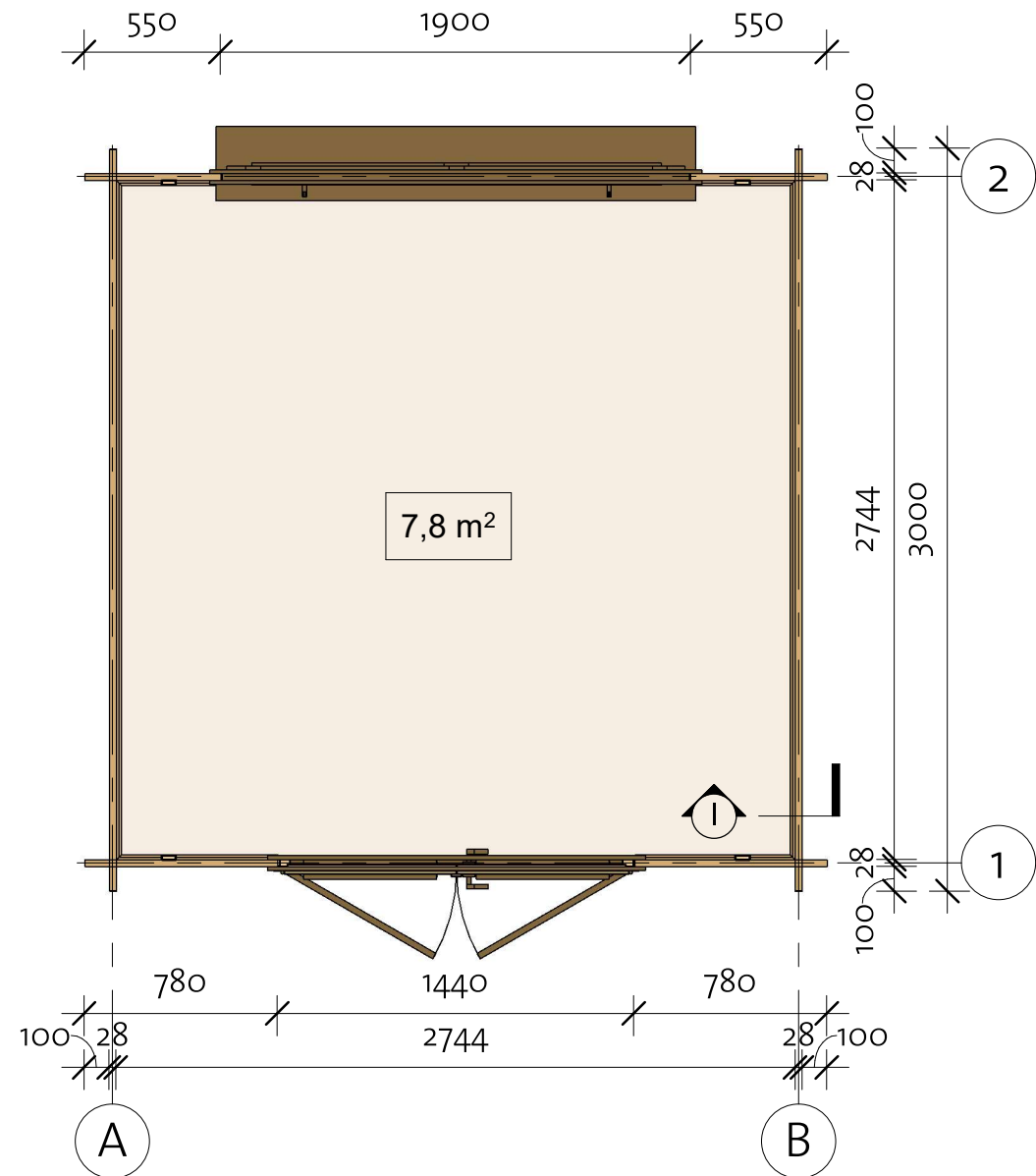

Kiosk 28 (280x280)

Wall 1

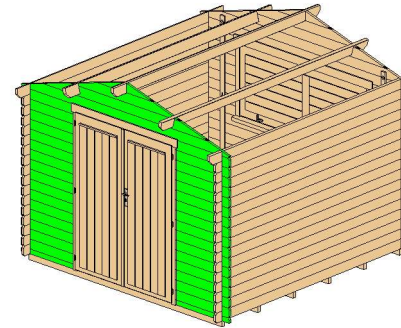

Wall 1			
Mark	Profile	Count	Cut Length

1BL 1	28x57	2	780
1LG 1	28x114	32	780
1LG 2*	28x114	1	794
1LG 3*	28x114	1	1588
1LG 4*	28x114	1	2382
1LG 5*	28x114	1	3000

*Gable-delivered premounted

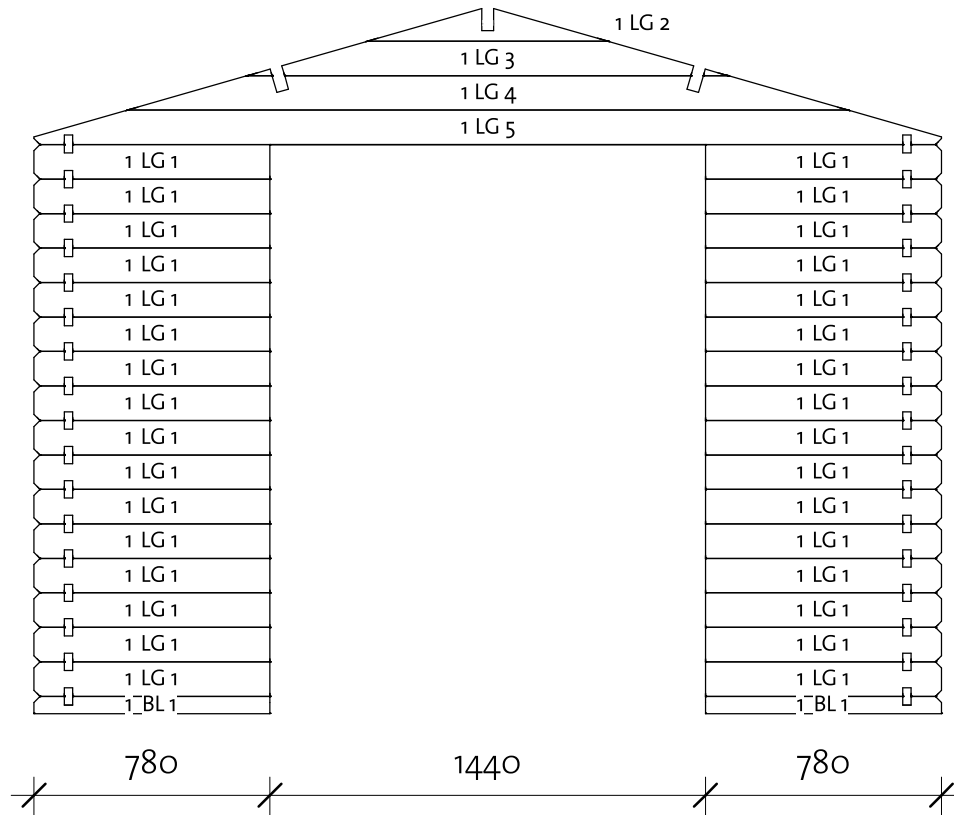

Log Profile Wall 1	
Profile	Profile

28x57	
28x114	

Kiosk 28 (280x280)

Wall 2

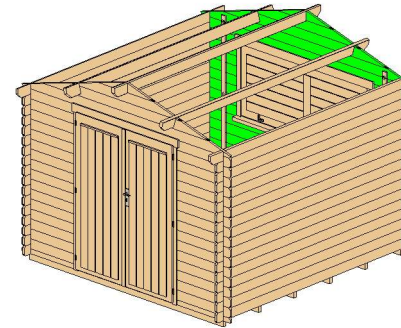

Wall 2			
Mark	Profile	Count	Cut Length

2BL 1	28x57	1	3000
2LG 1	28x114	16	550
2LG 2*	28x114	1	794
2LG 3*	28x114	1	1588
2LG 4*	28x114	1	2382
2LG 5*	28x114	1	3000
2LG 6	28x114	8	3000

*Gable-delivered premounted

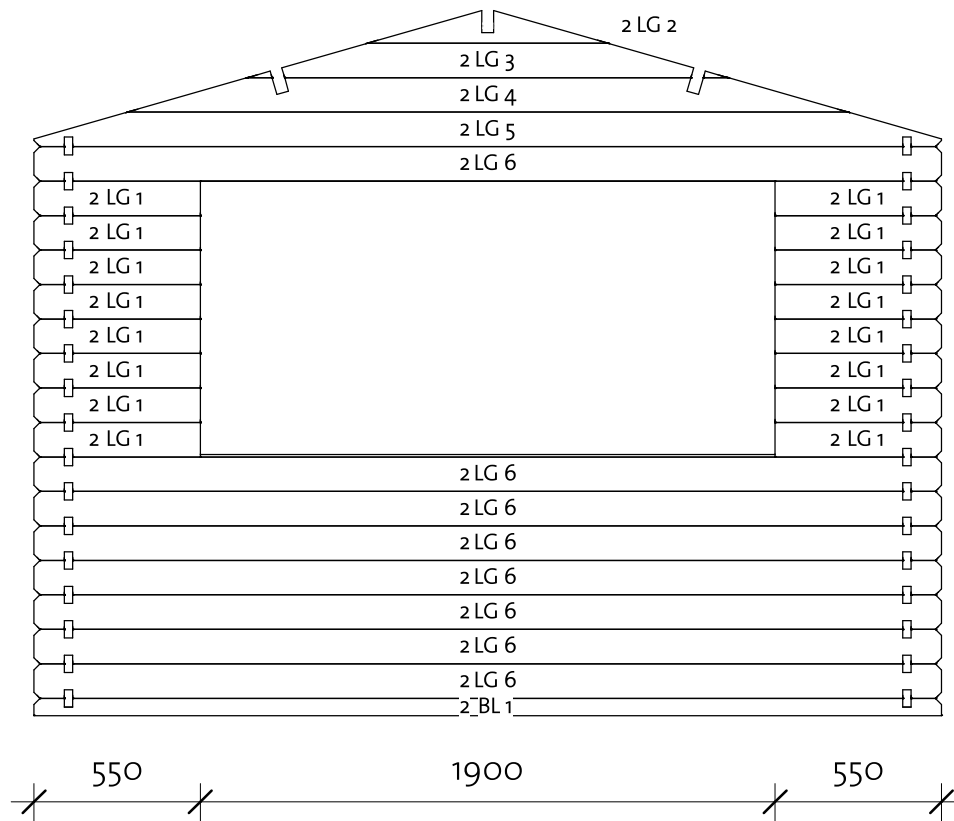

Log Profile Wall 2	
Profile	Profile

28x57	
28x114	

Kiosk 28 (280x280)

Wall A

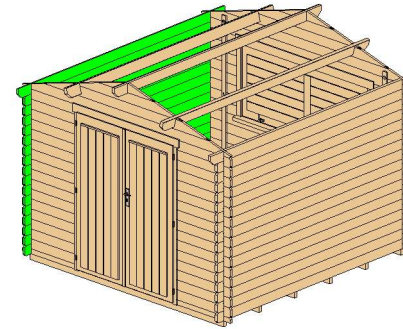

Wall A			
Mark	Profile	Count	Cut Length

ALG 1	28x114	16	3000
ATL 1	28x119	1	3200

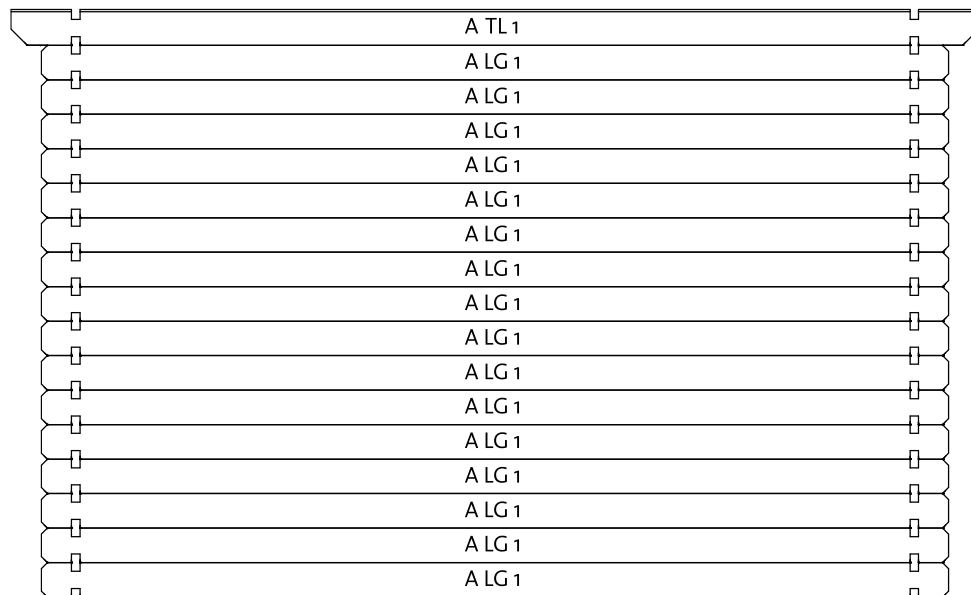

100
//

3000

100
//

Log Profile Wall A	
Profile	Profile

28x114	
28x119	

Kiosk 28 (280x280)

Wall B

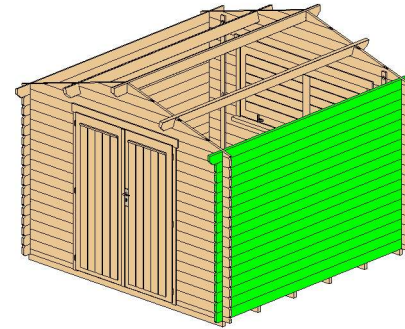

Wall B			
Mark	Profile	Count	Cut Length

BLG 1	28x114	16	3000
BTL 1	28x119	1	3200

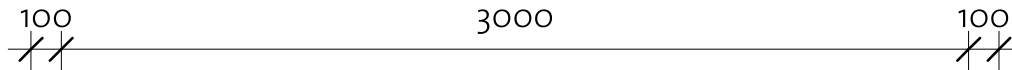
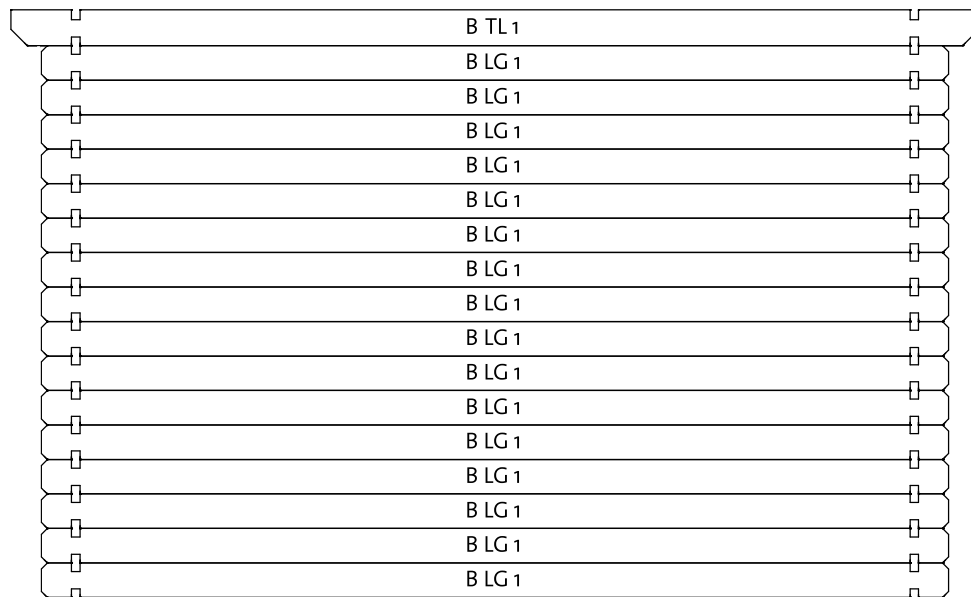





Log Profile Wall B	
Profile	Profile

28x114	
28x119	

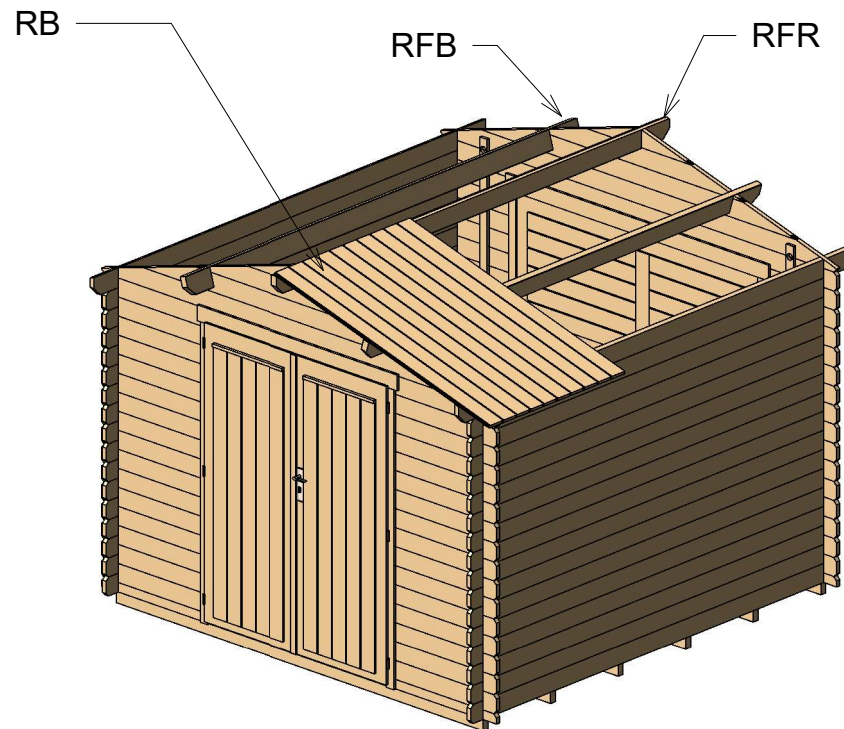
Kiosk 28 (280x280)

Roof 1



Roof				
Mark	Type	Profile	Count	Length
RFR	Ridge 40x120		1	3200
RFB	Beam 40x120		2	3200
RB	Roofboard 18x110		62	1695

Kiosk 28 (280x280)

Roof 2

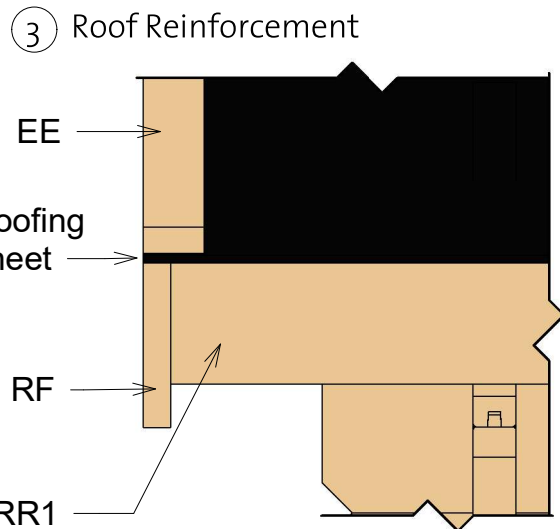
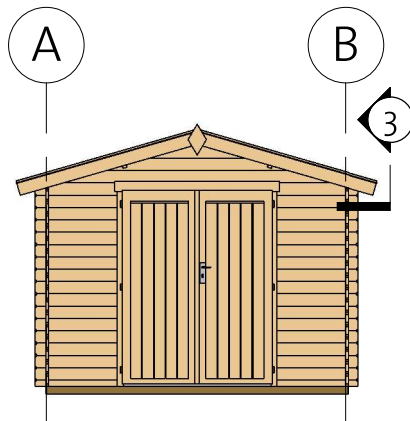
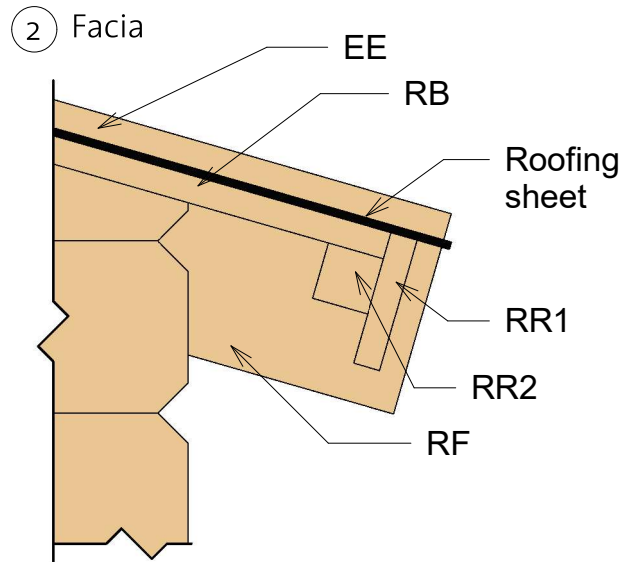
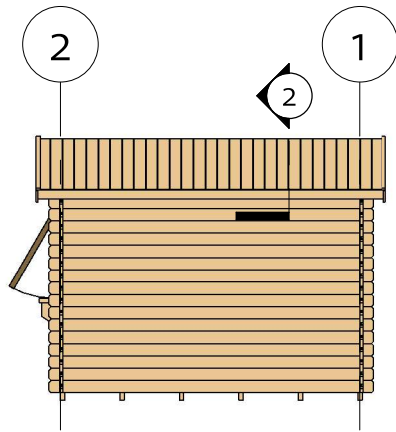

Fascia Schedule				
Mark	Type	Profile	Count	Length
EE	Eave Edging 18x40		4	1735
RF	Roof Fascia 18x115		4	1735
RR1	Roof reinforcement 18x90		2	3200
RR2	Roof reinforcement 38x38		2	3200

Kiosk 28 (280x280)

Extras

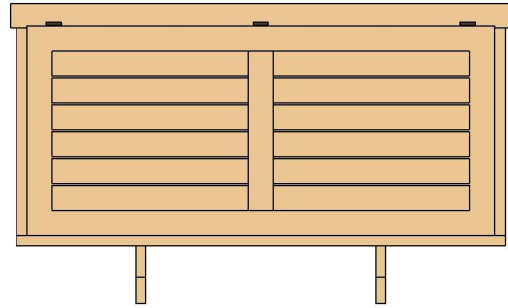
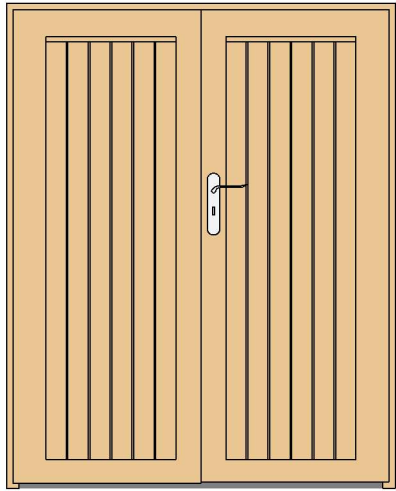

Schedule				
Model	Type	Width	Height	Count
BDD6R	Basic double door 6, wood right	1425	1835	1
KH1	Kiosk Hatch	1890	880	1

Fasteners & Extras		
Name	Type	Count

Hitblock	300-400 mm	
Bolts	M8 x 60	12
Screws	5,0 x 70	20
Screws	6,0 x 140	30
Nails	1,4x40	30
Screws	4,0 x 40	90
Screws	4,0 x 50	475



Type	Count	Lenght
------	-------	--------

Windboard 18x40	4	2200
-----------------	---	------



Family	Count
--------	-------

Romb	2
------	---

Kiosk 28 (280x280)

List of all items 1

Impregnated foundation beams

Mark	Type	Profile	Count	Length
------	------	---------	-------	--------

IFB	IFB 40x70		6	2790
-----	--------------	---	---	------

Floor Schedule



Mark	Type	Profile	Count	Length
------	------	---------	-------	--------

FB	FB 18x110		26	2740
----	-----------	---	----	------

BB	BB 20x40		4	2800
----	-------------	---	---	------





Roof

Mark	Type	Profile	Count	Length
------	------	---------	-------	--------

RFR	Ridge 40x120		1	3200
RFB	Beam 40x120		2	3200
RB	Roofboard 18x110		62	1695

Fascia Schedule

Mark	Type	Profile	Count	Length
------	------	---------	-------	--------

EE	Eave Edging 18x40		4	1735
RF	Roof Fascia 18x115		4	1735
RR1	Roof reinforcement 18x90		2	3200
RR2	Roof reinforcement 38x38		2	3200

Kiosk 28 (280x280)

List of all items 2

Wall 1			
Mark	Profile	Count	Cut Length

1BL 1	28x57	2	780
1LG 1	28x114	32	780
1LG 2*	28x114	1	794
1LG 3*	28x114	1	1588
1LG 4*	28x114	1	2382
1LG 5*	28x114	1	3000

Wall 2			
Mark	Profile	Count	Cut Length

2BL 1	28x57	1	3000
2LG 1	28x114	16	550
2LG 2*	28x114	1	794
2LG 3*	28x114	1	1588
2LG 4*	28x114	1	2382
2LG 5*	28x114	1	3000
2LG 6	28x114	8	3000

*Gable-delivered premounted



Wall A			
Mark	Profile	Count	Cut Length

ALG 1	28x114	16	3000
ATL 1	28x119	1	3200

Wall B			
Mark	Profile	Count	Cut Length

BLG 1	28x114	16	3000
BTL 1	28x119	1	3200

Log Profiles	
Profile	Profile

28x57	
28x114	
28x119	