

Ontario Bunkie 160 40 (305x488)

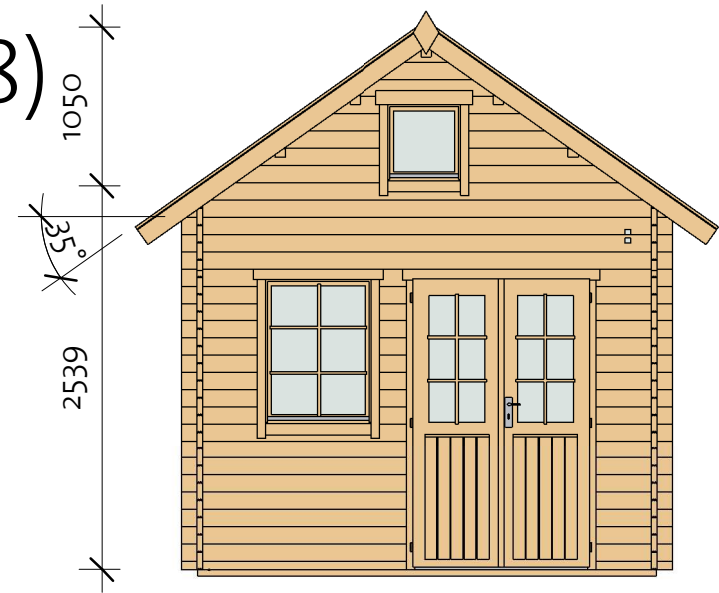

Ontario Bunkie 160 40 (305x488)

Foundation

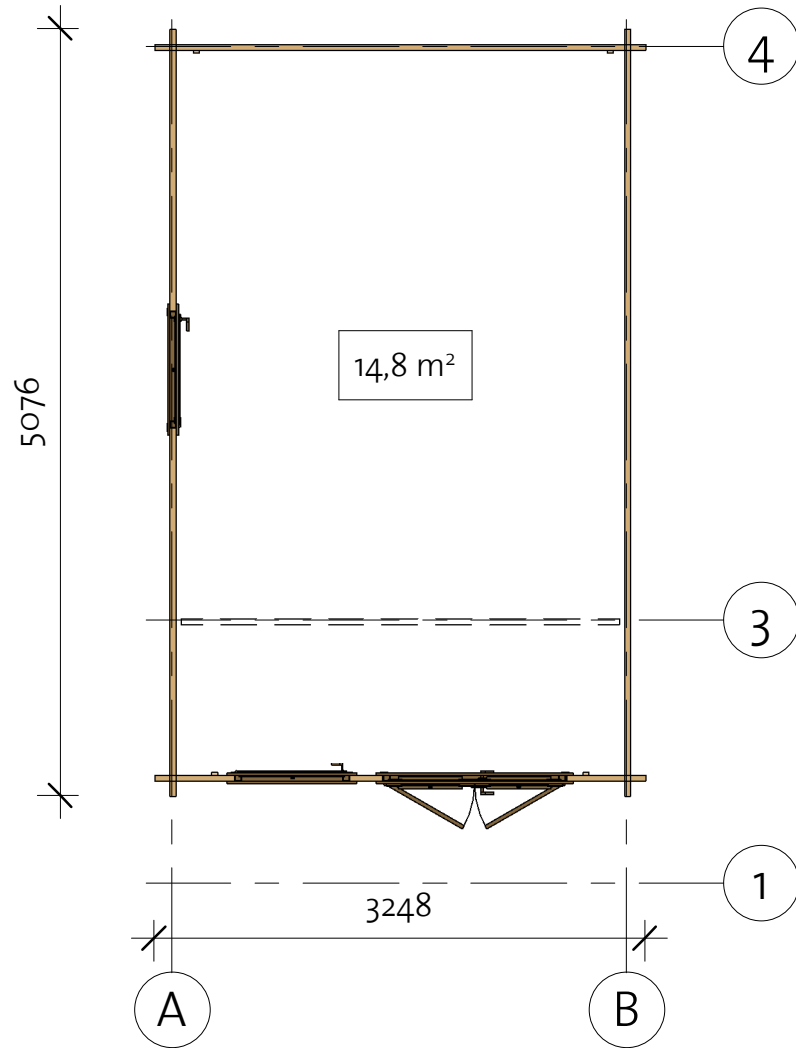
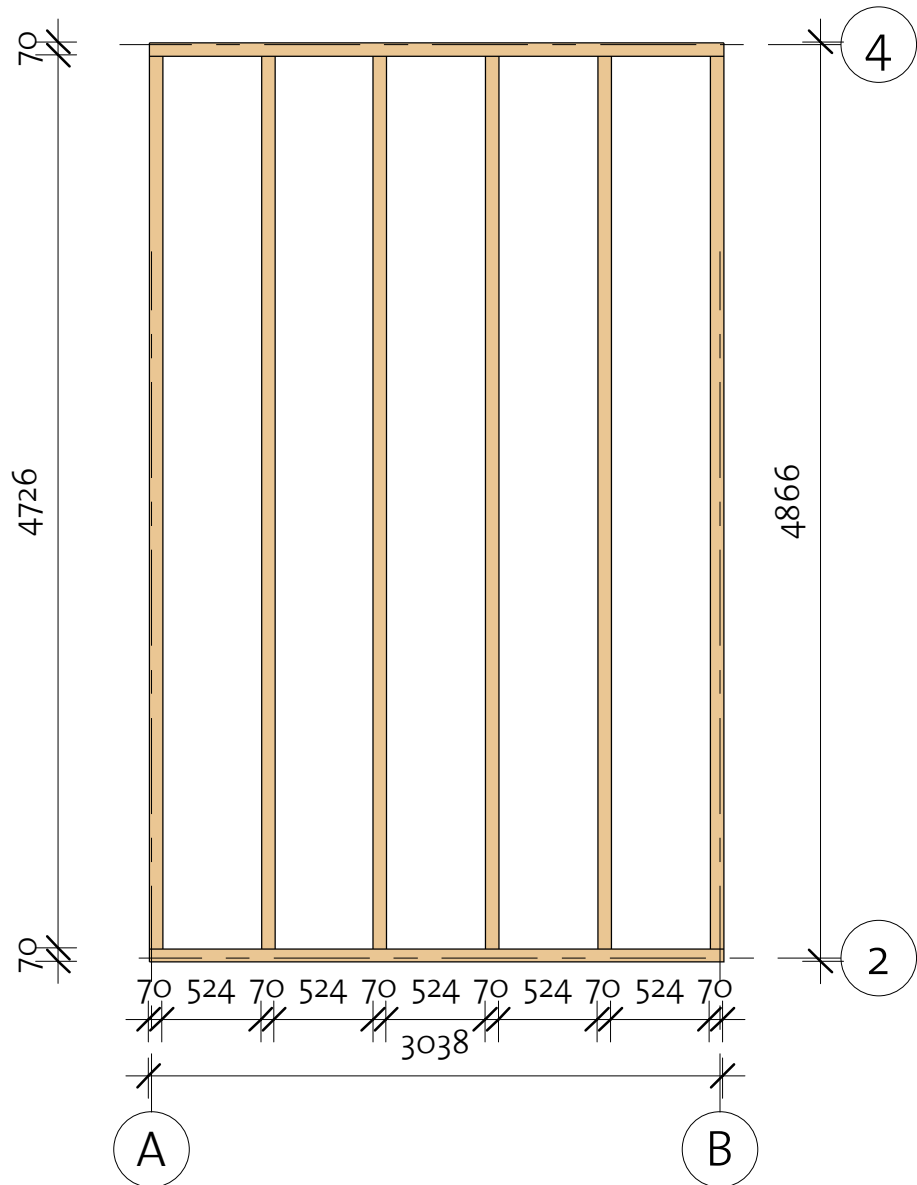

Impregnated foundation beams				
Mark	Type	Profile	Count	Length
IFB1	IFB 70x40		6	4726
IFB2	IFB 70x40		2	3038



Ontario Bunkie 160 40 (305x488)

Floor Plan

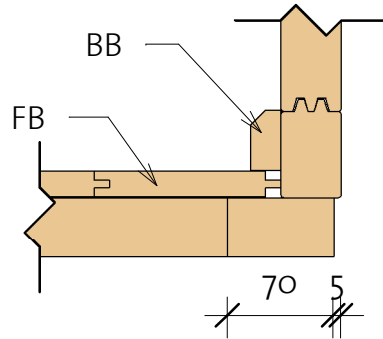
① Baseboard



Floor Schedule				
Mark	Type	Profile	Count	Length

FB1	FB 17x114		44	2962
FB2	FB 17x114		27	1850

BB1	BB 20x40		2	4900
BB2	BB 20x40		4	3100

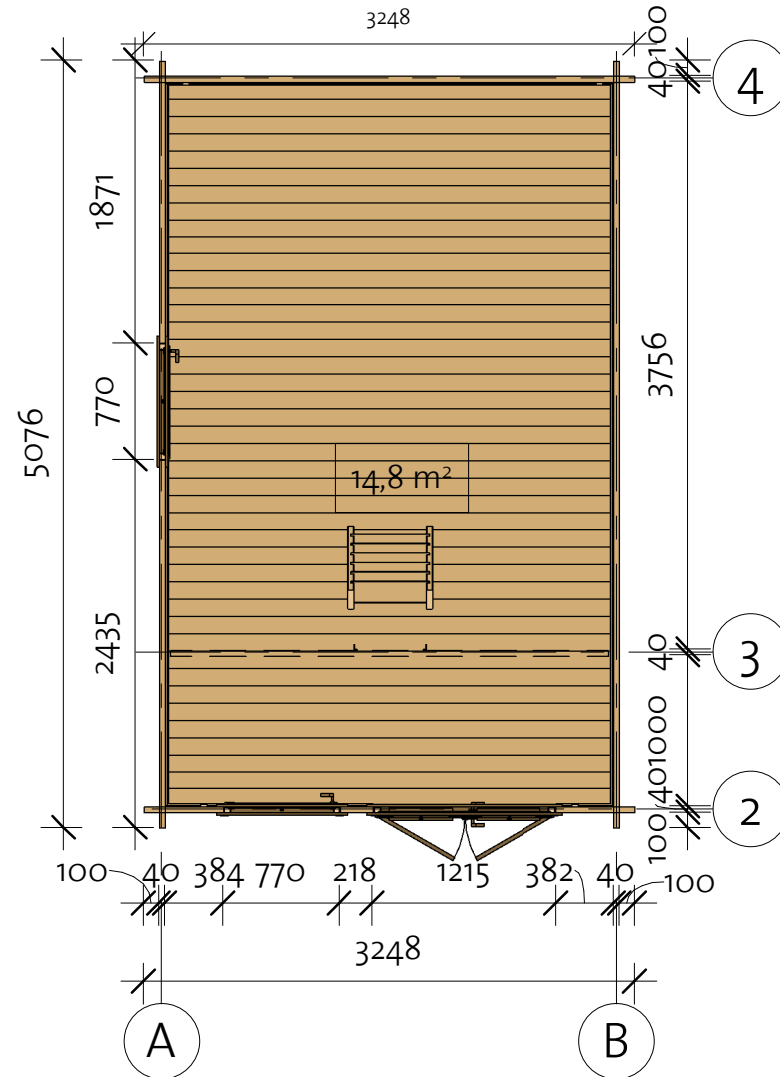

Ontario Bunkie 160 40 (305x488)

Wall 1

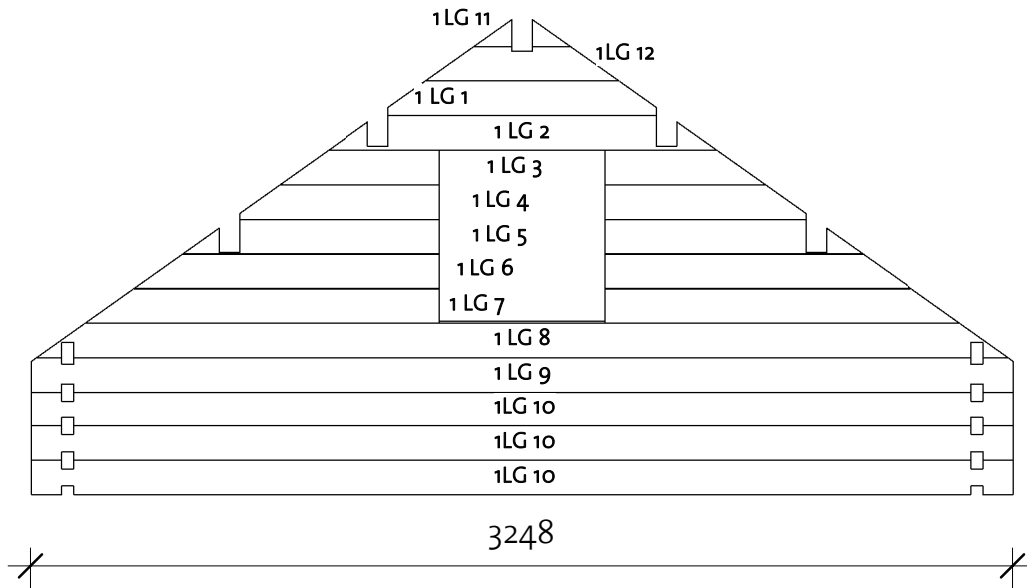
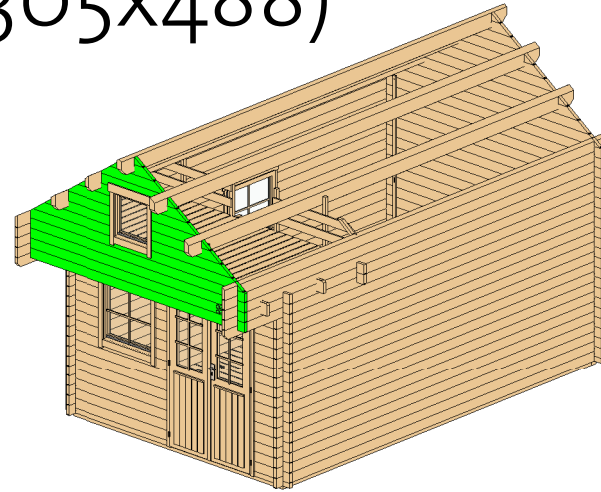

Wall 1			
Mark	Profile	Count	Cut Length

1LG 1 *	40X114	1	884
1LG 2 *	40X114	1	1284
1LG 3 *	40X114	2	530
1LG 4 *	40X114	2	664
1LG 5 *	40X114	2	853
1LG 6 *	40X114	2	1011
1LG 7 *	40X114	2	1175
1LG 8 *	40X114	1	3217
1LG 9 *	40X114	1	3248
1LG 10	40X114	3	3248
1LG 11 *	40X114	1	317
1LG 12 *	40X114	1	639

* Gable - delivered premounted

Log Profile Wall 1	
Profile	Profile

40X114	
--------	--

Ontario Bunkie 160 40 (305x488)

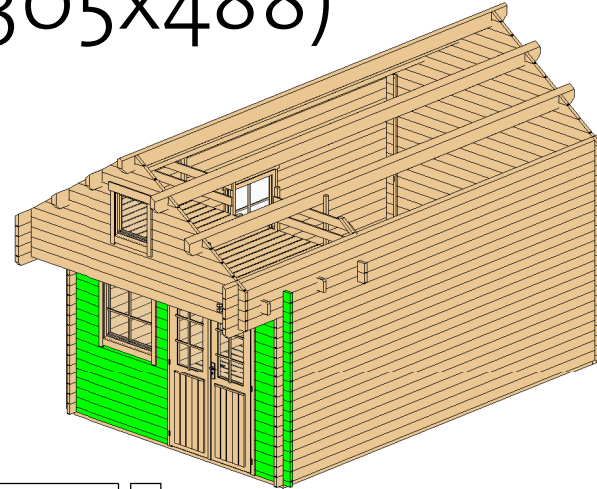

Wall 2



Wall 2			
Mark	Profile	Count	Cut Length

2BL 1	40X57	1	524
2BL 2	40X57	1	1514
2LG 1	40X114	9	220
2LG 2	40X114	26	524
2LG 3	40X114	8	1514
2LG 4	40X114	1	3248
2LG 5	40X114	1	3248

Log Profile Wall 2	
Profile	Images4

40X57	
40X114	
40X114	

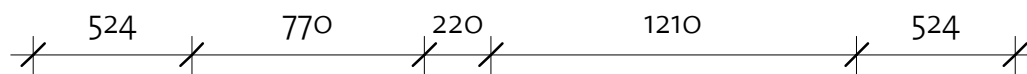
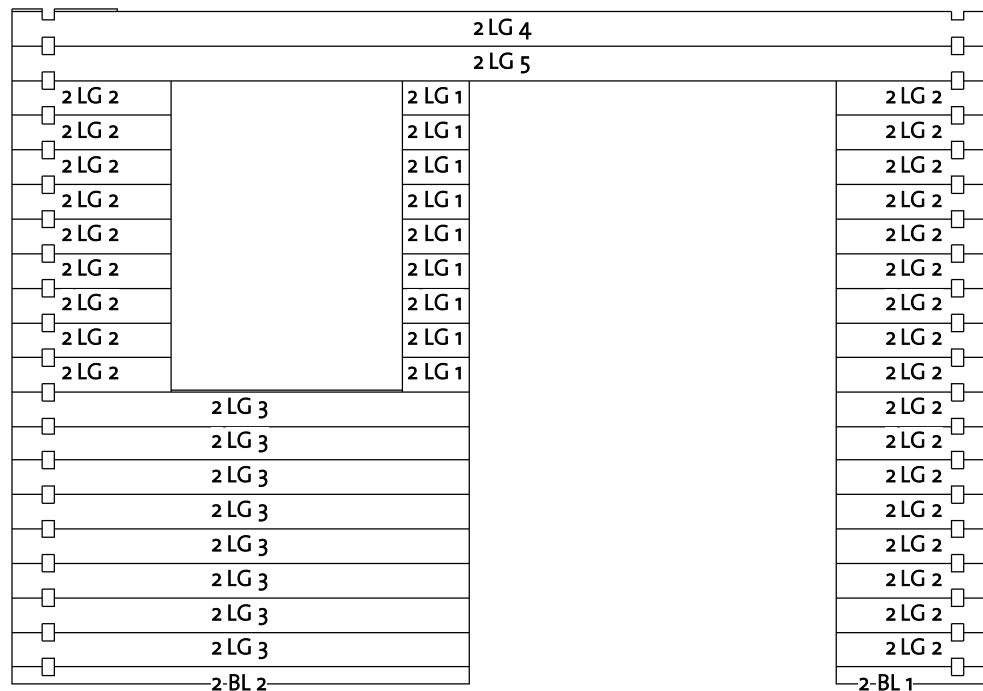

Ontario Bunkie 160 40 (305x488)

Wall 3

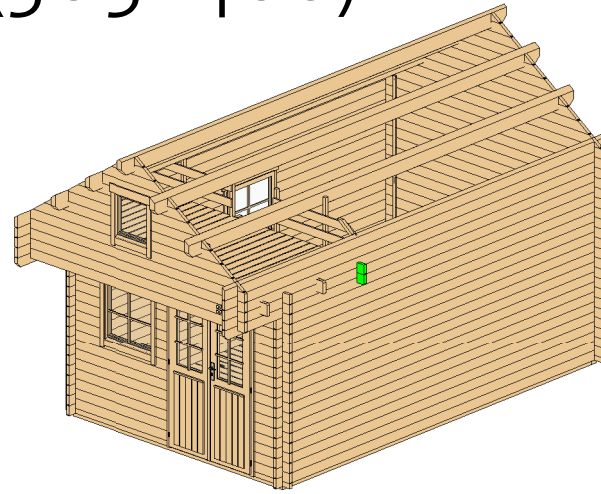

Wall 3			
Mark	Profile	Count	Cut Length

3LG 1	40X114	1	3248
3LG 2	40X114	1	3248

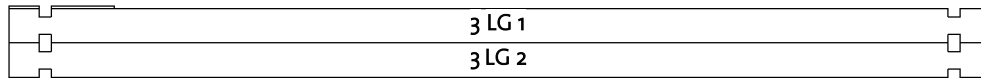

Log Profile Wall 3	
Profile	Images4

40X114	
40X114	

Ontario Bunkie 160 40 (305x488)

Wall 4

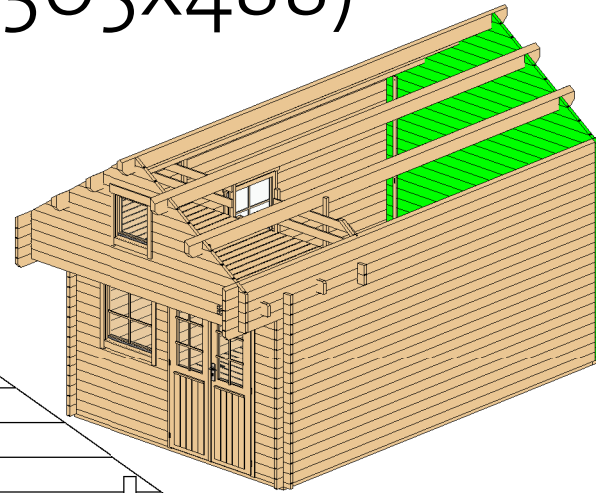
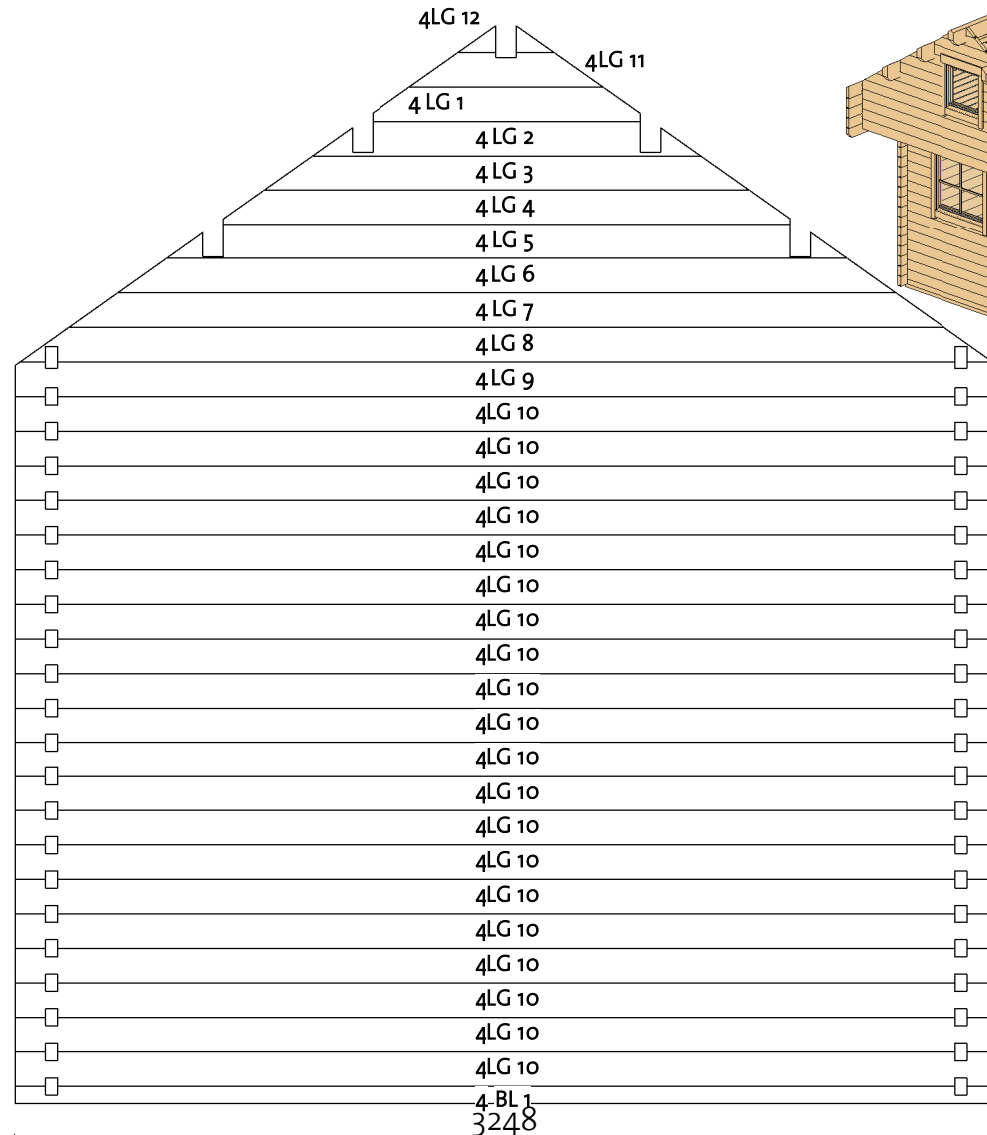

Wall 4			
Mark	Profile	Count	Cut Length

4BL 1	40X57	1	3248
4LG 1 *	40X114	1	884
4LG 2 *	40X114	1	1284
4LG 3 *	40X114	1	1606
4LG 4 *	40X114	1	1873
4LG 5 *	40X114	1	2250
4LG 6 *	40X114	1	2572
4LG 7 *	40X114	1	2895
4LG 8 *	40X114	1	3217
4LG 9 *	40X114	1	3248
4LG 10	40X114	20	3248
4LG 11 *	40X114	1	639
4LG 12 *	40X114	1	317

* Gable - delivered premounted

Log Profile Wall 4	
Profile	Profile

40X57	
-------	---

Log Profile Wall 4	
Profile	Profile

40X114	
--------	---

Ontario Bunkie 160 40 (305x488)

Wall A

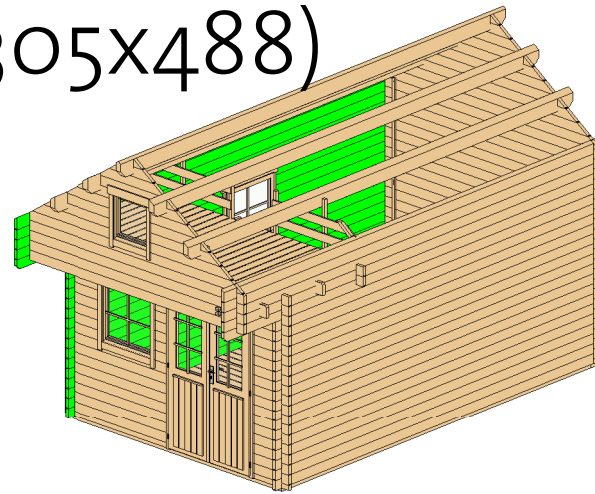

Wall A			
Mark	Profile	Count	Cut Length

ALG 1	40x114	9	1871
ALG 2	40x114	9	2435
ALG 3	40x114	8	5076
ALG 4	40x114	1	5876
ALG 5	40x114	1	5976
ALG 6	40x114	2	5876
ATL 1	40x145	1	5976

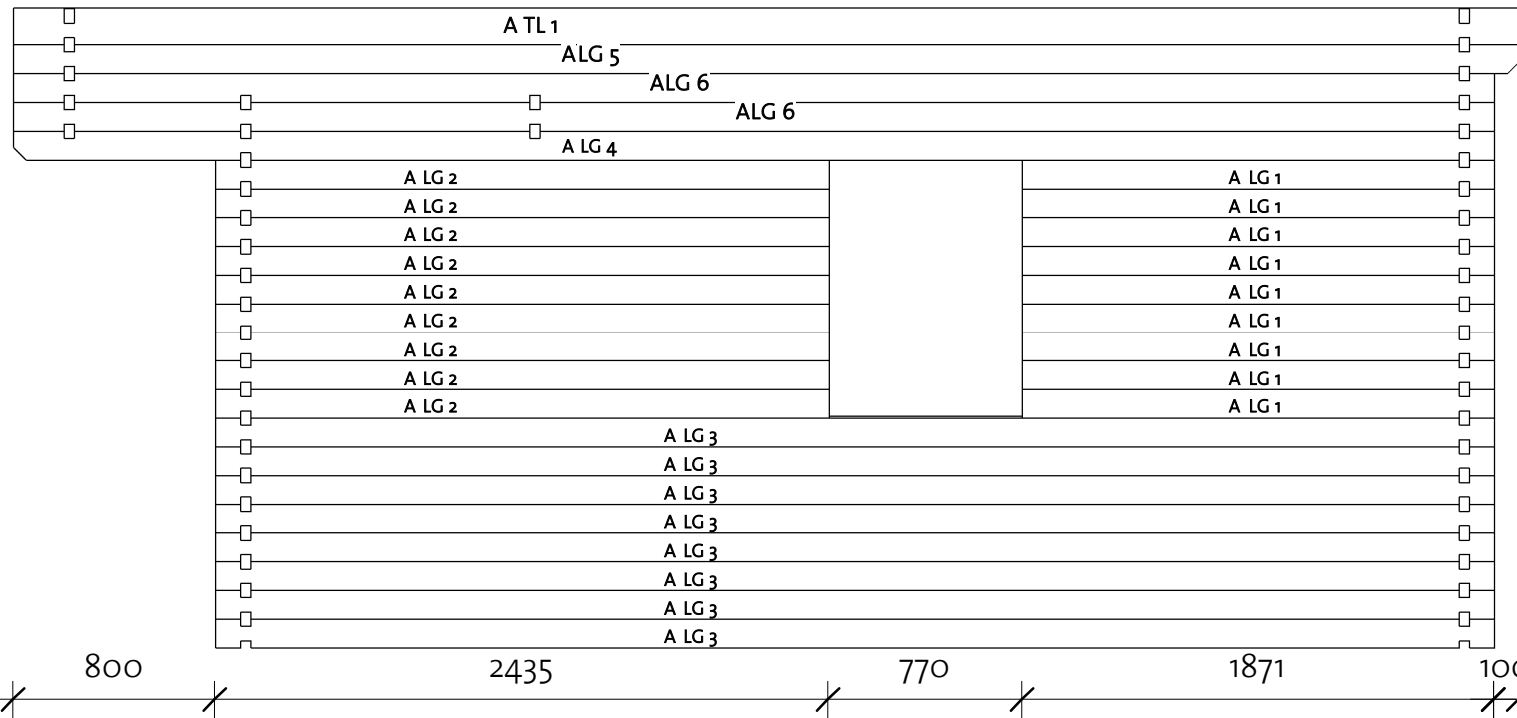

Log Profile Wall A	
Profile	Profile

40x114	
40x145	

Ontario Bunkie 160 40 (305x488)

Wall B

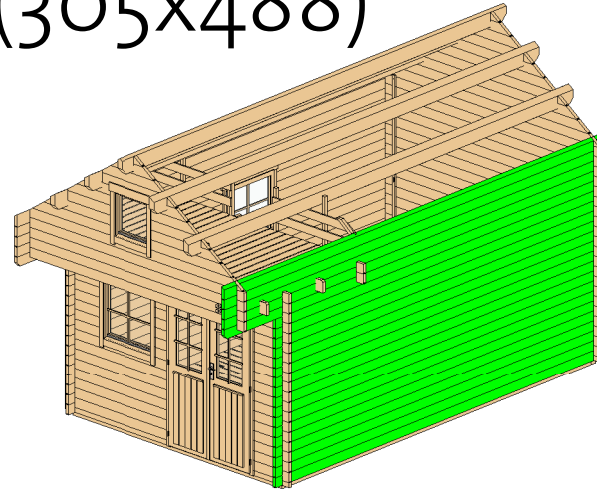

Wall B			
Mark	Profile	Count	Cut Length

BLG 1	40x114	17	5076
BLG 2	40x114	3	5876
BLG 3	40x114	1	5976
BTL 1	40x145	1	5976

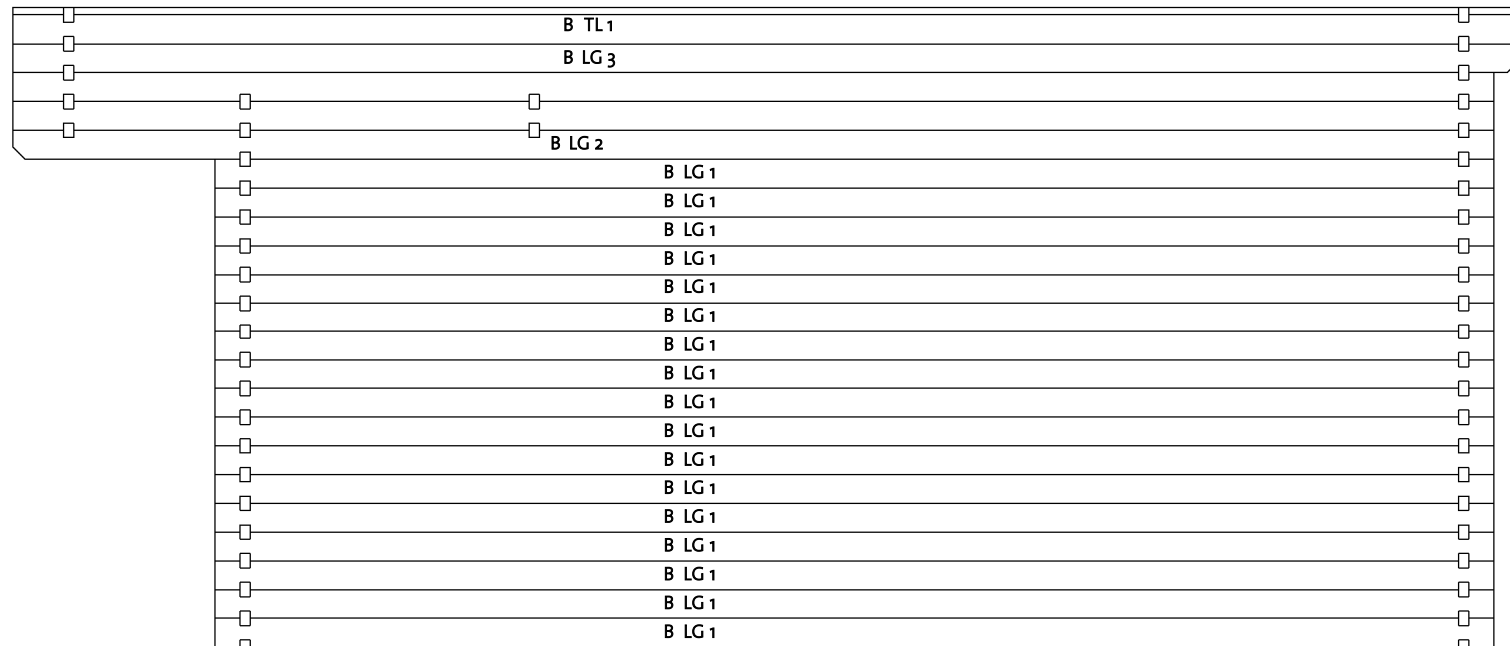

Log Profile Wall B	
Profile	Profile

40x114	
40x145	

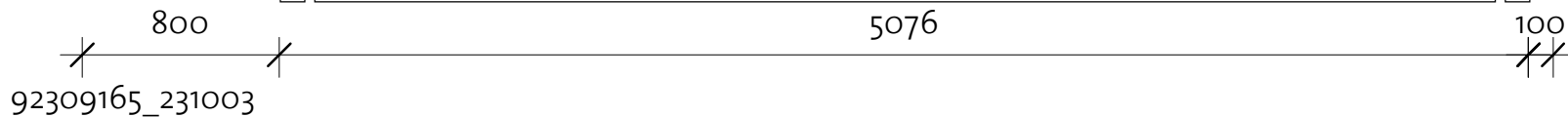

Ontario Bunkie 160 40 (305x488)

Second floor

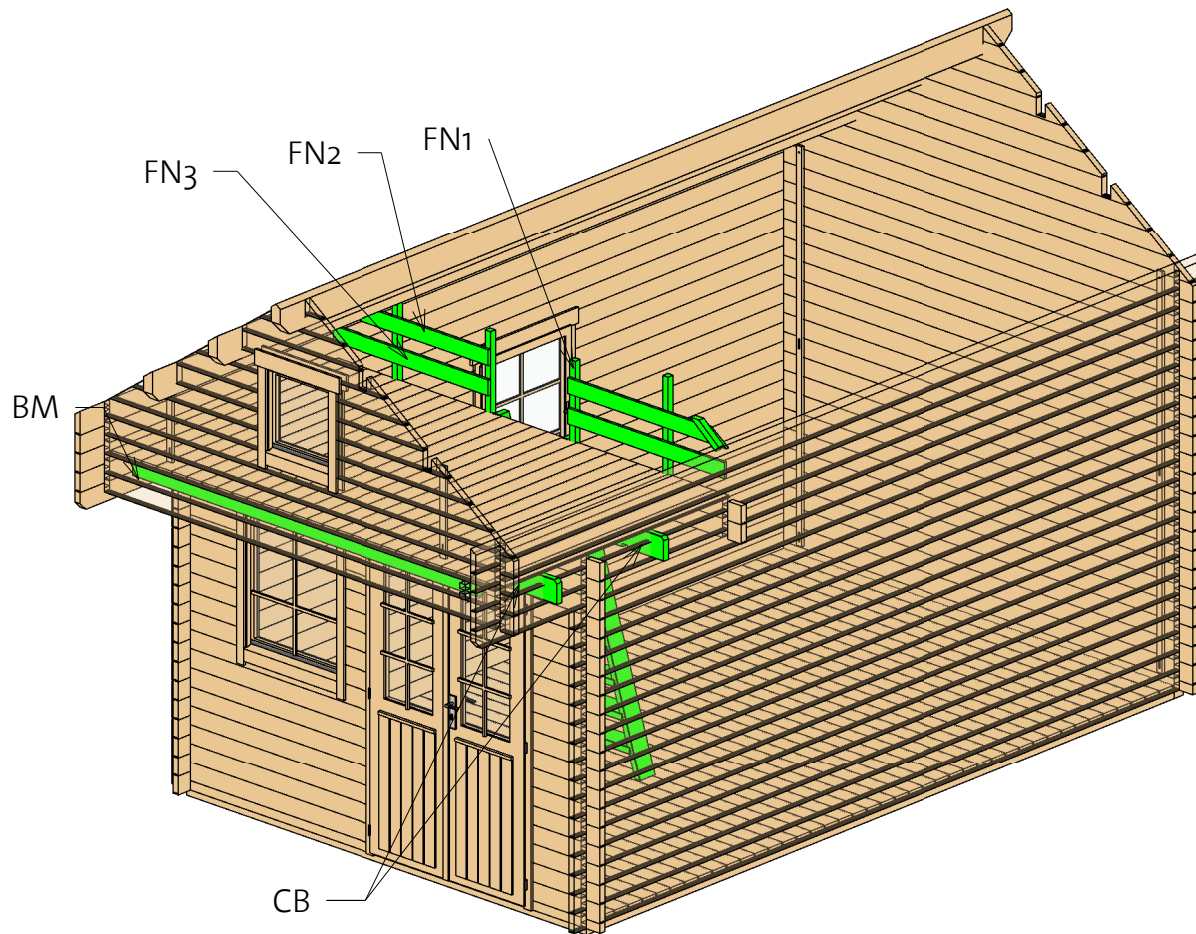

Second floor 5,8 m2

Second floor				
Mark	Type	Profile	Count	Cut Length
FN3	Fence3 18x95		2	1184
BM	Beam 40x90		1	2620
CB	Ceiling beam 40x143		2	3248
FN1	Fence1 38x38		4	680
FN1	Fence1 38x38		2	780
FN2	Fence2 18x95		2	1200

Ontario Bunkie 160 40 (305x488)

Fence

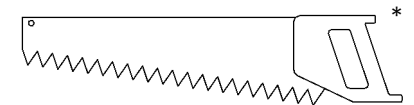
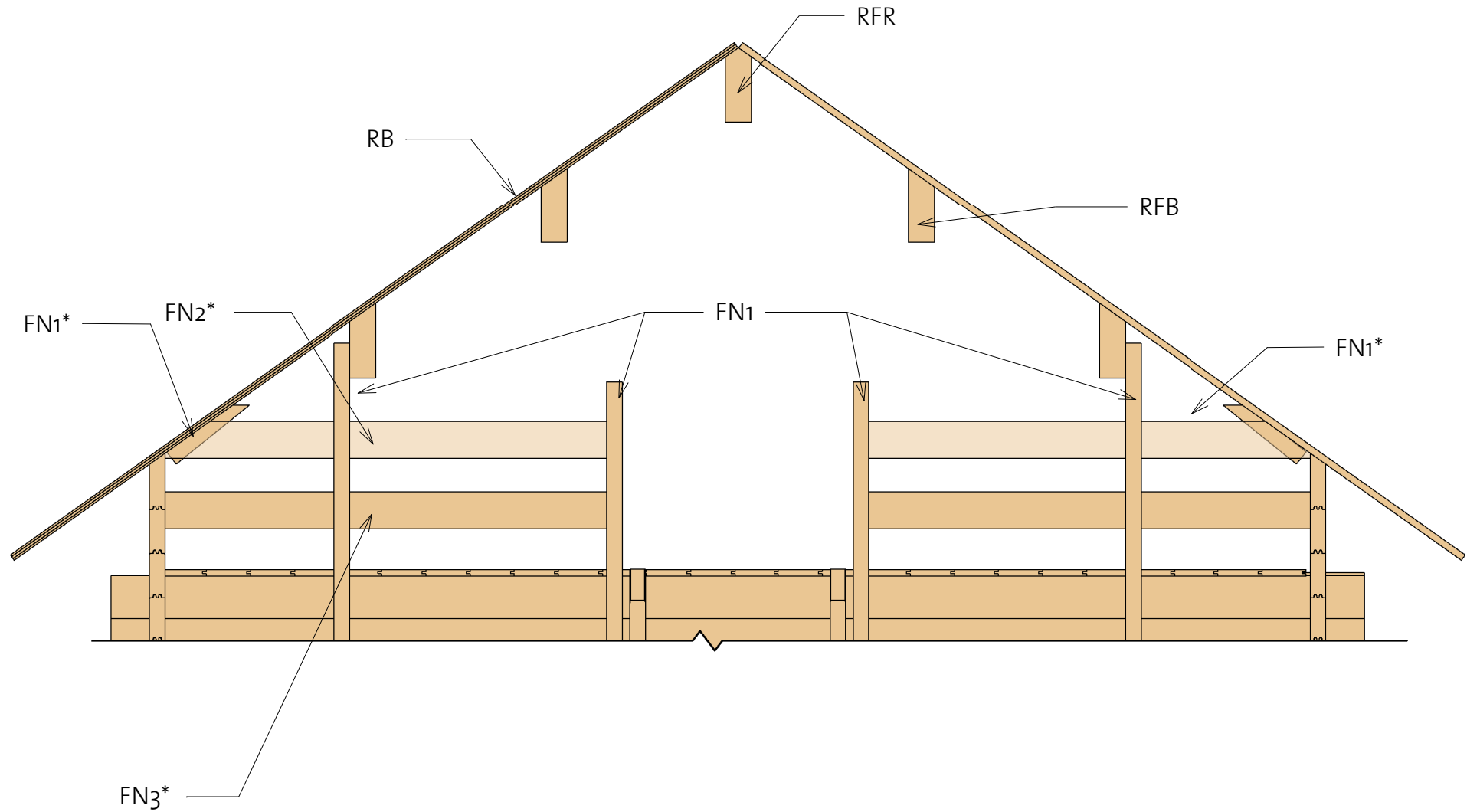

Ontario Bunkie 160 40 (305x488)

Stair

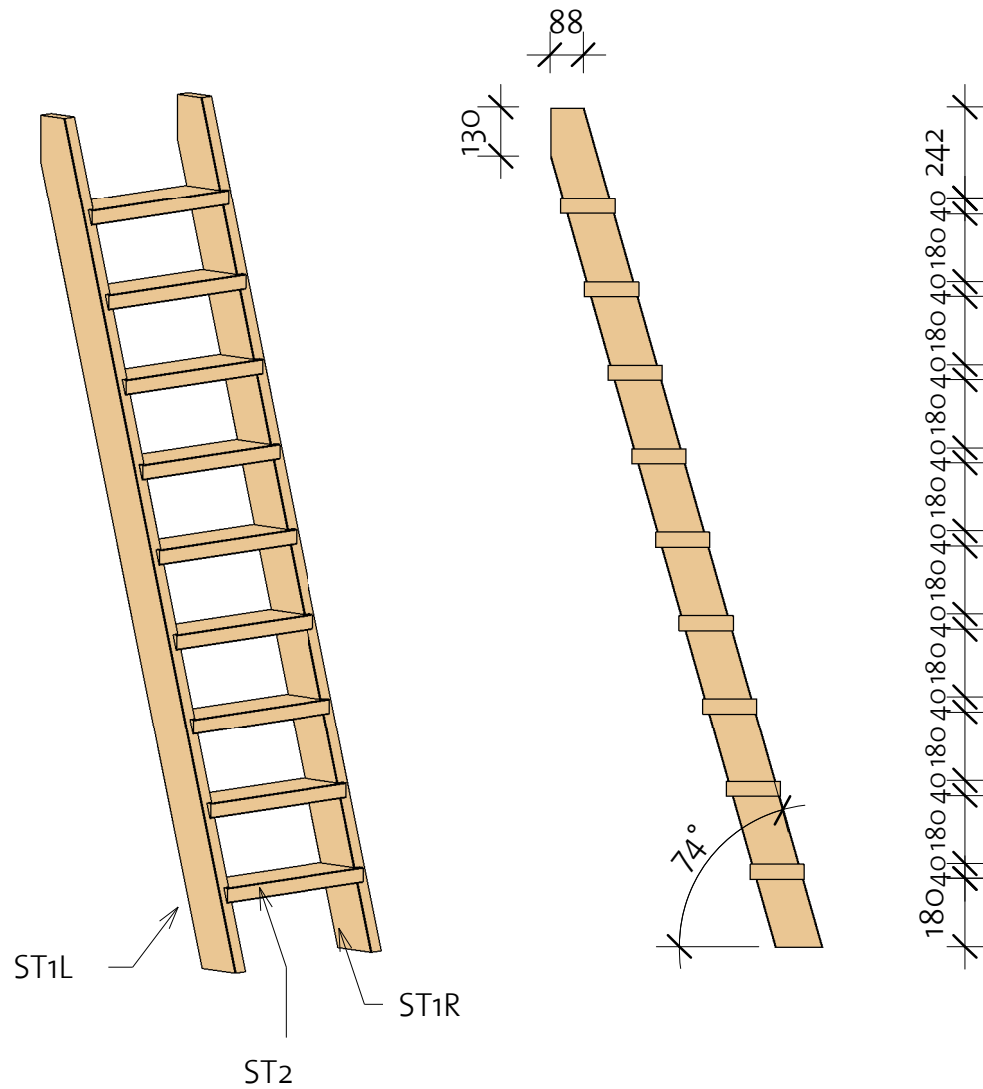



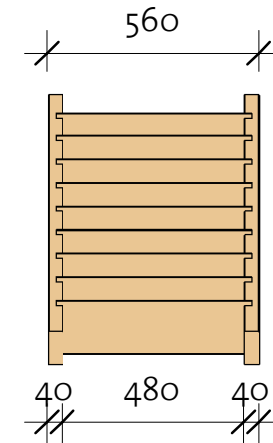

Stairs				
Mark	Profile	Profile	Count	Cut Length
ST1L	40X120		1	2333
ST1R	40X120		1	2333
ST2	143X40		9	520

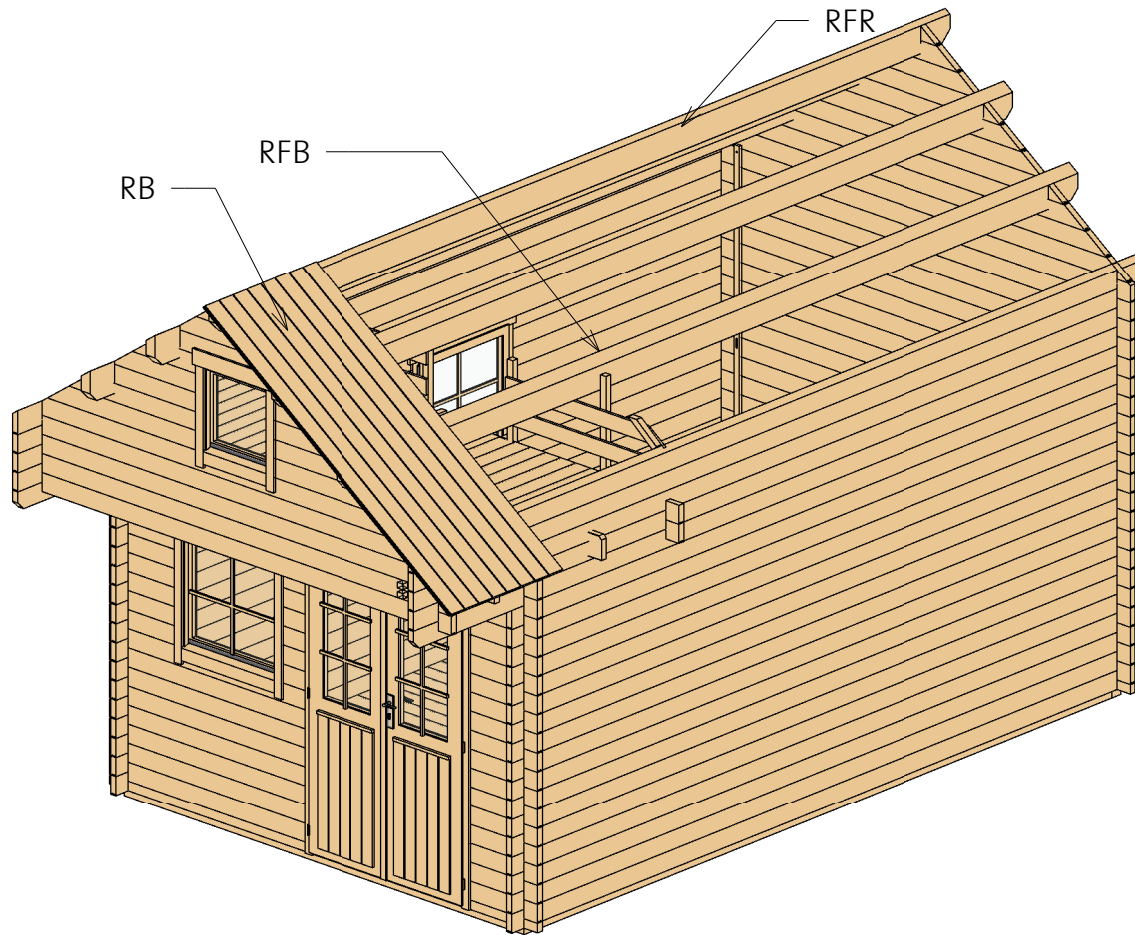

Ontario Bunkie 160 40 (305x488)

Roof 1

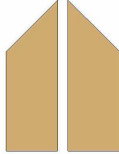

Roof				
Mark	Type	Profile	Count	Length
RFR	Ridge 68x193		1	5976
RFB	Beam 68x193		2	5976
RB	17x114		108	2295

Ontario Bunkie 160 40 (305x488)

Roof 2

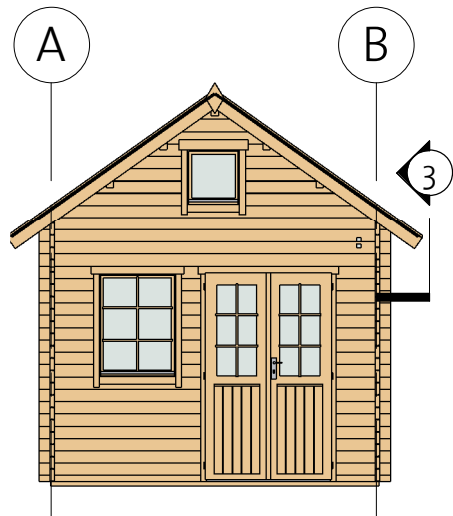
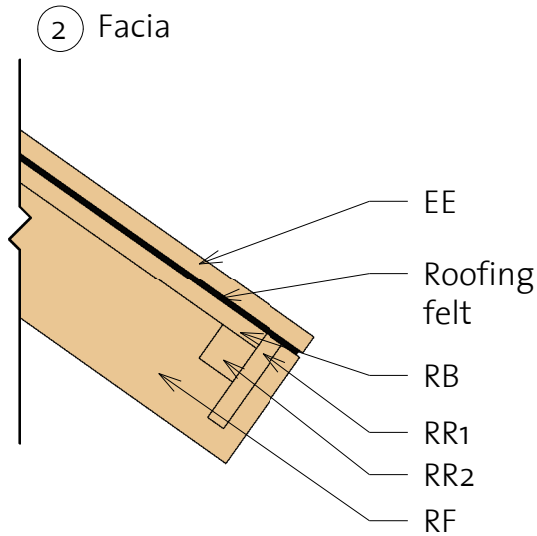
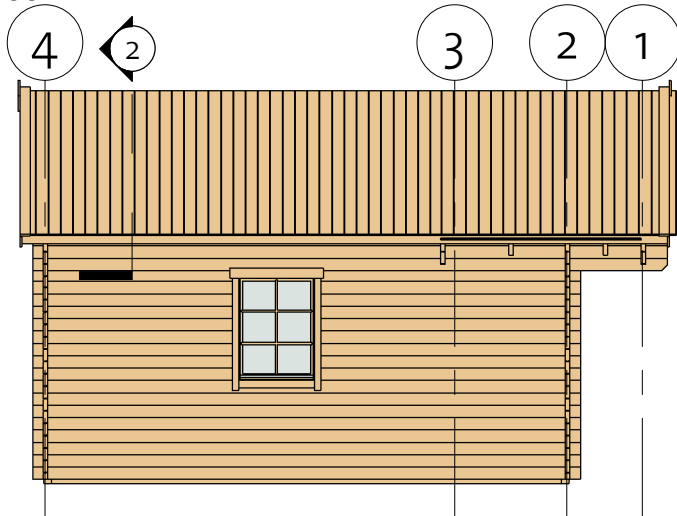

3 Roof Reinforcement

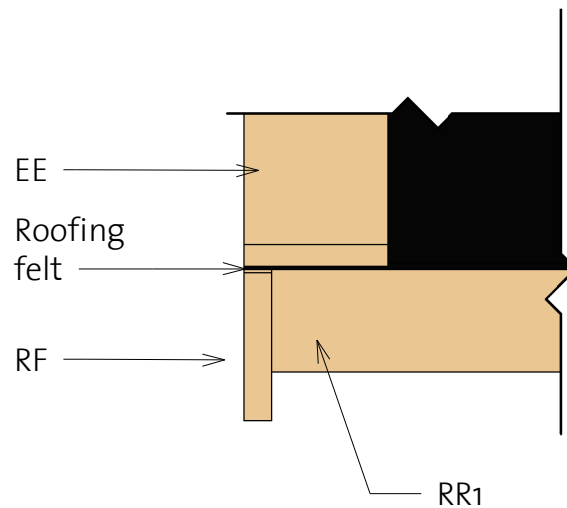

Fascia Schedule

Mark	Type	Profile	Count	Length
EE	Eave Edging 18x95		4	2346
RF	Roof Fascia 18x120		4	2346
RR1	Roof reinforcement 18x95		2	5976
RR2	Roof reinforcement 38x38		2	5976

Ontario Bunkie 160 40 (305x488)

Extras

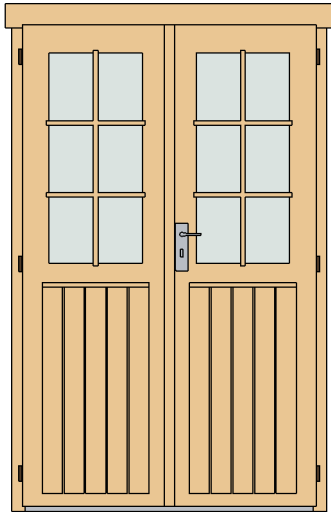

Door Schedule				
Model	Type	Width	Height	Count
CDD5R	Classic double door 5 right	1200	1955	1
DCB6-5	Door Crossbar 6-5	--	--	2

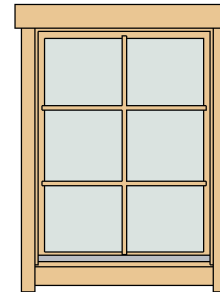

Window Schedule				
Model	Type	Width	Height	Count
CW1R	Classic window 1 right	765	990	2
CW12R	Classic window 12 right	540	540	1
WCB6	Windows Crossbar 6	--	--	2

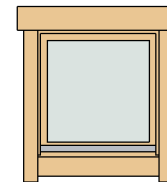

Fasteners & Extras		
Name	Type	Count

Hitblock	300-400 mm	
Ladder fittings		2
Screws	6,0x160	6
Bolts	M8 x 70	20
Screws	5,0 x 70	45
Nails	1,4 x 40	50
Screws	6,0 x 140	80
Screws	4,0 x 40	820

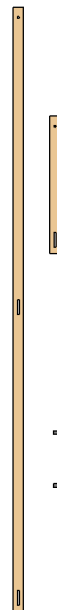

Type	Count	Length
Windboard1 18x40	2	2400
Windboard2 18x40	2	550
Windboard2 18x40	2	2150

Family	Count
--------	-------

Romb	2
------	---





92309165_231003

Ontario Bunkie 160 40 (305x488)

List of all items 1

Impregnated foundation beams



Mark	Type	Profile	Count	Length
------	------	---------	-------	--------

IFB1	IFB 70x40		6	4726
IFB2	IFB 70x40		2	3038

BB1	BB 20x40		2	4900
BB2	BB 20x40		4	3100



Floor Schedule

Mark	Type	Profile	Count	Length
------	------	---------	-------	--------

FB1	FB 17x114		44	2962
FB2	FB 17x114		27	1850



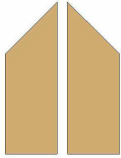

Roof

Mark	Type	Profile	Count	Length
------	------	---------	-------	--------

RFR	Ridge 68x193		1	5976
RFB	Beam 68x193		2	5976
RB	17x114		108	2295

Fascia Schedule

Mark	Type	Profile	Count	Length
------	------	---------	-------	--------

EE	Eave Edging 18x95		4	2346
RF	Roof Fascia 18x120		4	2346
RR1	Roof reinforcement 18x95		2	5976
RR2	Roof reinforcement 38x38		2	5976

Ontario Bunkie 160 40 (305x488)

List of all items 2

Wall 1			
Mark	Profile	Count	Cut Length

1LG 1 *	40X114	1	884
1LG 2 *	40X114	1	1284
1LG 3 *	40X114	2	530
1LG 4 *	40X114	2	664
1LG 5 *	40X114	2	853
1LG 6 *	40X114	2	1011
1LG 7 *	40X114	2	1175
1LG 8 *	40X114	1	3217
1LG 9 *	40X114	1	3248
1LG 10	40X114	3	3248
1LG 11*	40X114	1	317
1LG 12 *	40X114	1	639

Wall 4			
Mark	Profile	Count	Cut Length

4BL 1	40X57	1	3248
4LG 1 *	40X114	1	884
4LG 2 *	40X114	1	1284
4LG 3 *	40X114	1	1606
4LG 4 *	40X114	1	1873
4LG 5 *	40X114	1	2250
4LG 6 *	40X114	1	2572
4LG 7 *	40X114	1	2895
4LG 8 *	40X114	1	3217
4LG 9 *	40X114	1	3248
4LG 10*	40X114	20	3248
4LG 11*	40X114	1	639
4LG 12	40X114	1	317

Wall 2			
Mark	Profile	Count	Cut Length



2BL 1	40X57	1	524
2BL 2	40X57	1	1514
2LG 1	40X114	9	220
2LG 2	40X114	26	524
2LG 3	40X114	8	1514
2LG 4	40X114	1	3248
2LG 5	40X114	1	3248

Wall 3			
Mark	Profile	Count	Cut Length

3LG 1	40X114	1	3248
3LG 2	40X114	1	3248

*Gable-delivered premounted

Log Profiles 1	
Profile	Profile

40X57	
40X114	
40X114	

Ontario Bunkie 160 40 (305x488)

List of all items 3

Wall A			
Mark	Profile	Count	Cut Length

ALG 1	40X114	9	1871
ALG 2	40X114	9	2435
ALG 3	40X114	8	5076
ALG 4	40X114	1	5876
ALG 5	40X114	1	5976
ALG 6	40X114	2	5876
ATL 1	40X145	1	5976

Wall B			
Mark	Profile	Count	Cut Length





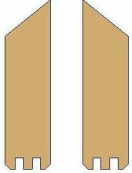



BLG 1	40X114	17	5076
BLG 2	40X114	3	5876
BLG 3	40X114	1	5976
BTL 1	40X145	1	5976

Log Profiles 2	
Profile	Profile

40X114	
40X145	

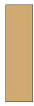
Ontario Bunkie 160 40 (305x488)

List of all items 4

Second floor					Stairs				
Mark	Type	Profile	Count	Cut Length	Mark	Profile	Profile	Count	Cut Length
FN3	Fence3 18x95		2	1184	ST1L	40x120		1	2333
BM	Beam 40x90		1	2620	ST1R	40x120		1	2333
CB	Ceiling beam 40x143		2	3248	ST2	143x40		9	520
FN1	Fence1 38x38		4	680					
FN1	Fence1 38x38		2	780					
FN2	Fence2 18x95		2	1200					