

Toronto 160 28 (192 1/8" x 120 1/8")

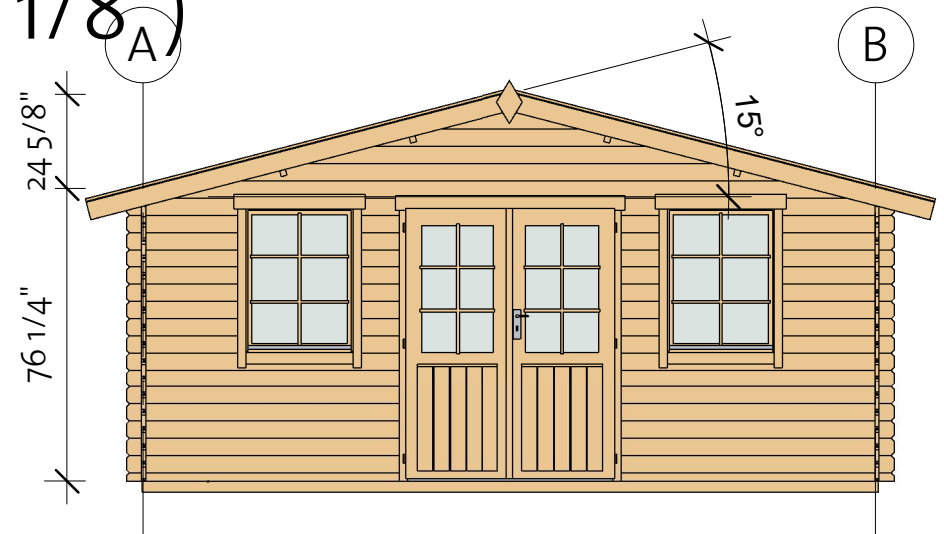

Toronto 160 28 (192 1/8" x 120 1/8")

Foundation

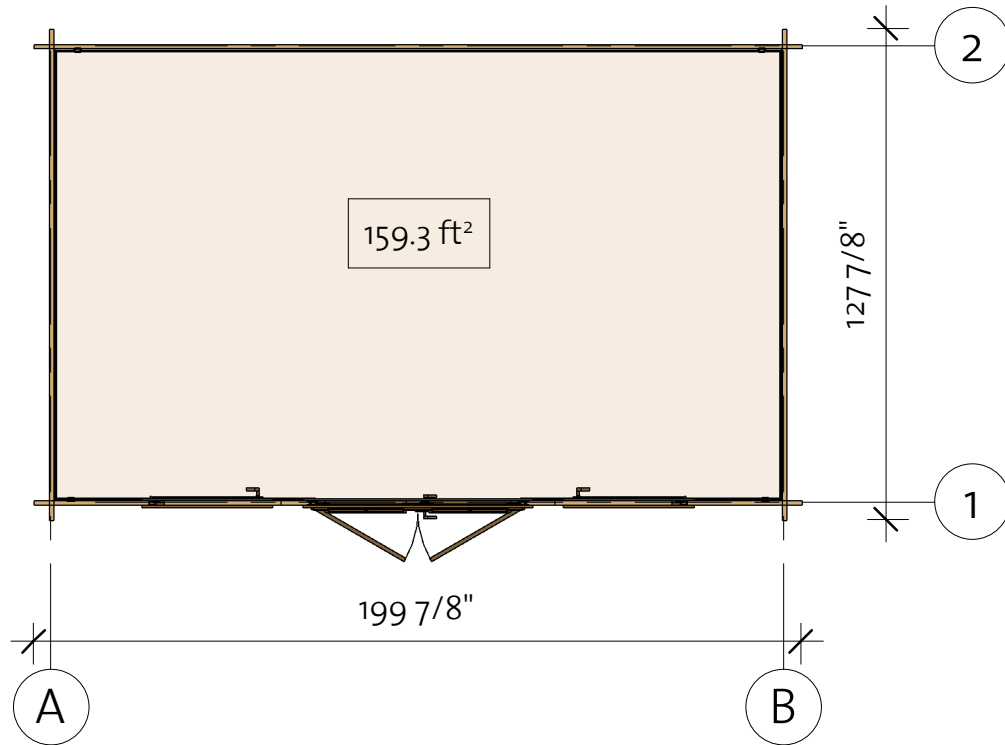
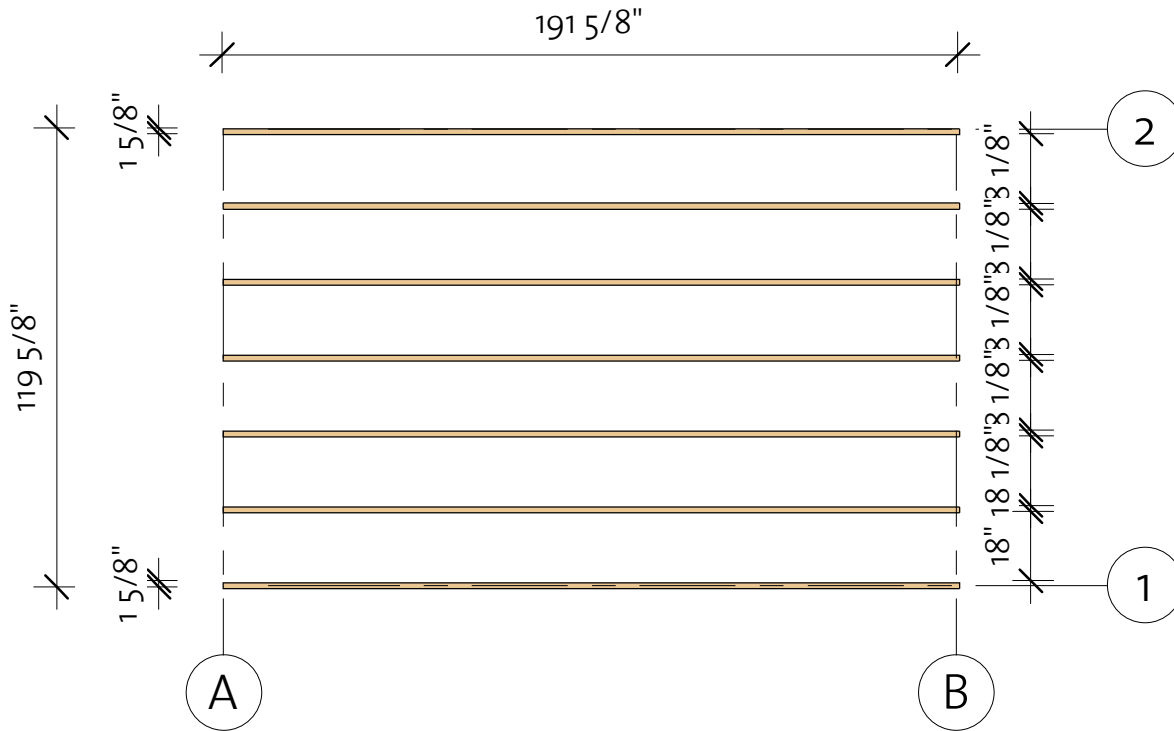

Impregnated foundation beams				
Mark	Type	Profile	Count	Length



IFB	IFB 40x70		7	191 5/8"
-----	--------------	---	---	-------------

Toronto 160 28 (192 1/8" x 120 1/8")

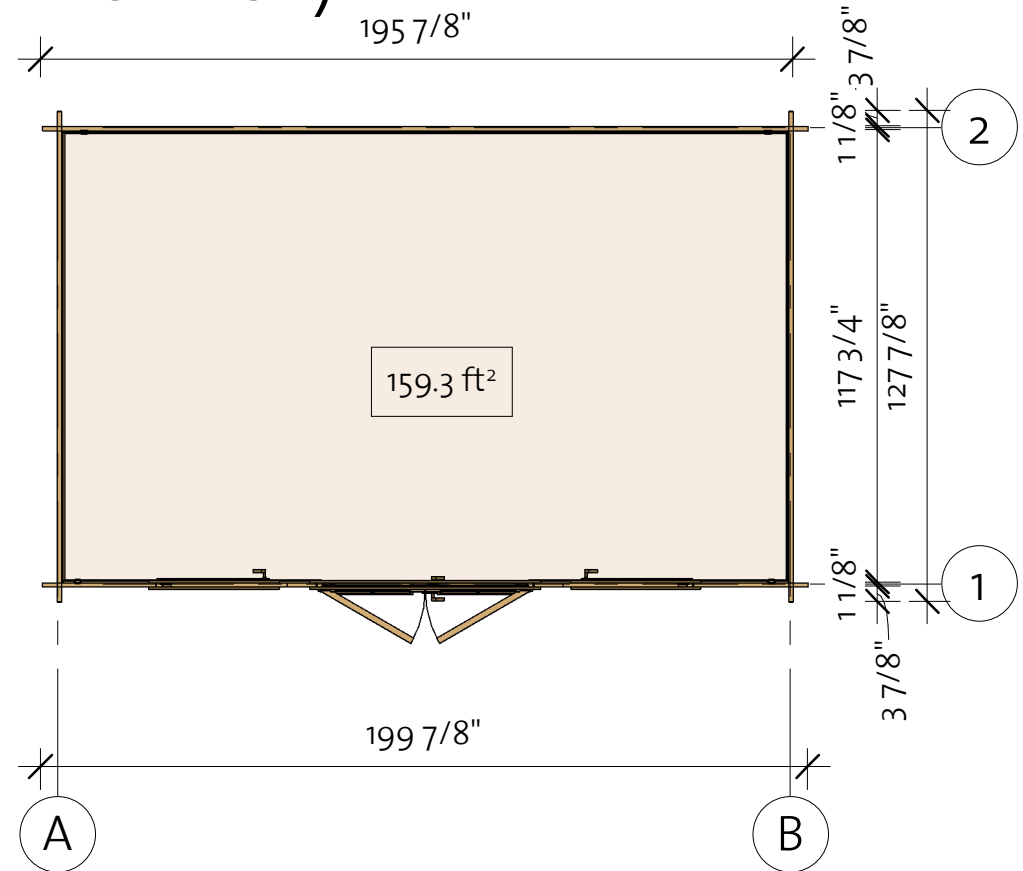
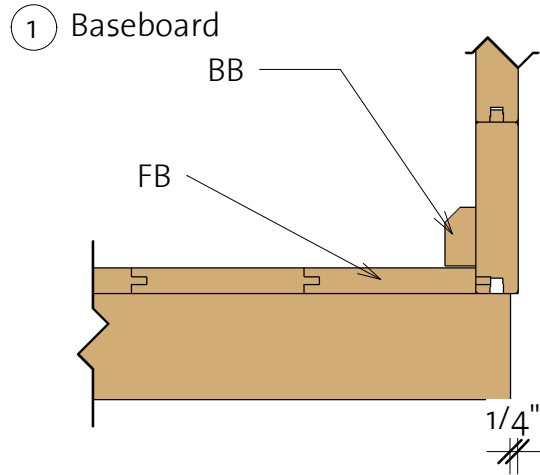
Floor Plan



Floor Schedule

Mark	Type	Profile	Count	Length
FB	FB 17x114		44	117 1/2"
BB1	BB 20x40		2	192 7/8"
BB2	BB 20x40		2	122"

Toronto 160 28 (192 1/8" x 120 1/8")

Wall 1

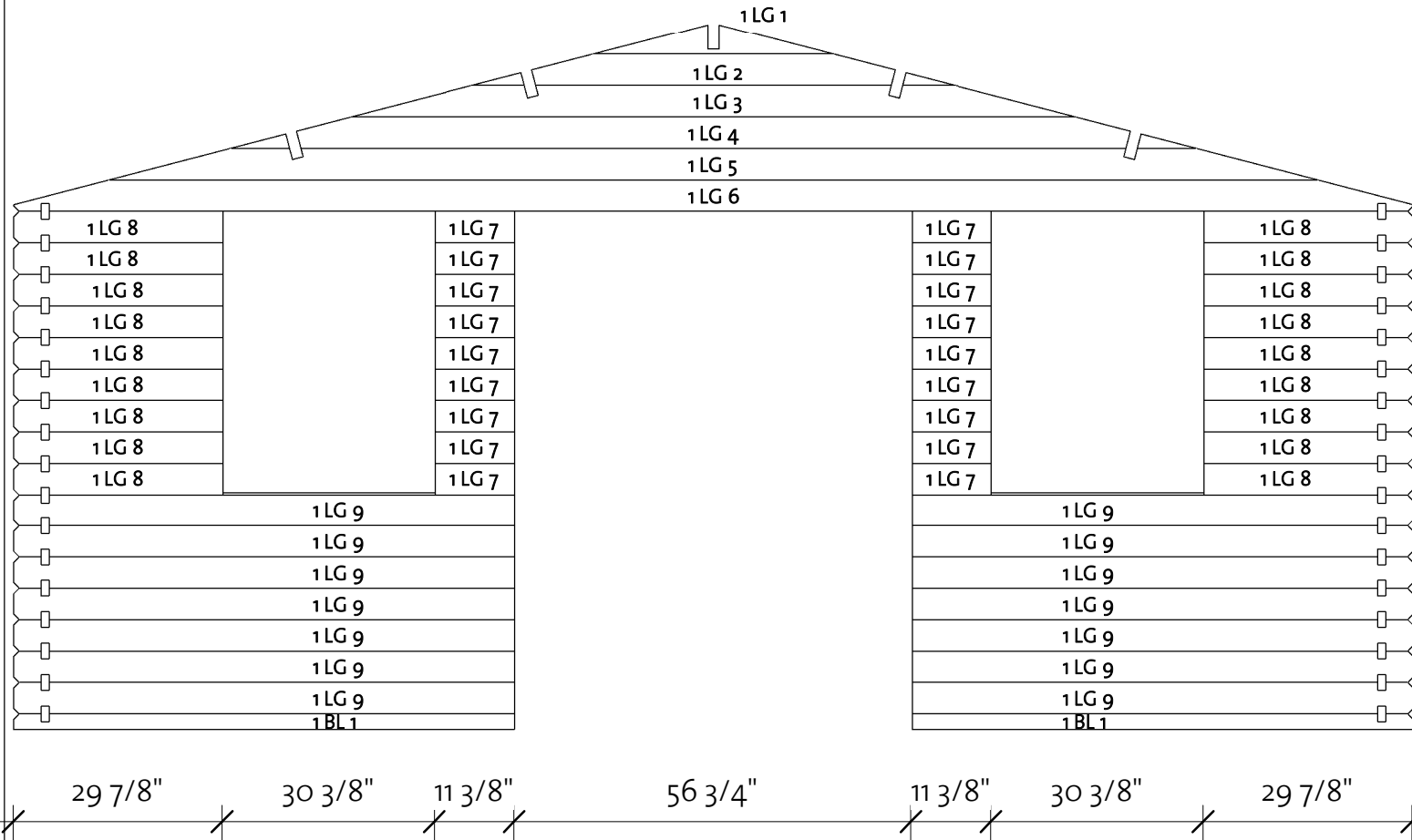
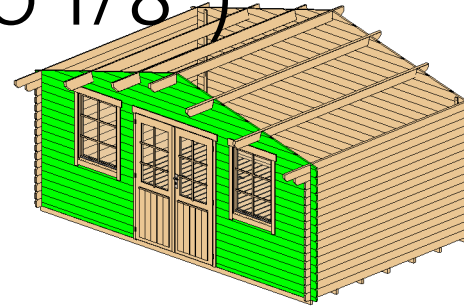



Wall 1			
Mark	Profile	Count	Cut Length

1BL 1	28x57	2	71 5/8"
1LG 1 *	28x114	1	34"
1LG 2 *	28x114	1	68 5/8"
1LG 3 *	28x114	1	103 1/4"
1LG 4 *	28x114	1	137 7/8"
1LG 5 *	28x114	1	172 1/2"
1LG 6 *	28x114	1	199 7/8"
1LG 7	28x114	18	11 3/8"
1LG 8	28x114	18	29 7/8"
1LG 9	28x114	14	71 5/8"

*Gable-delivered premounted

Log Profile Wall 1	
Profile	Profile

28x114	
28x57	

Toronto 160 28 (192 1/8" x 120 1/8")

Wall 2

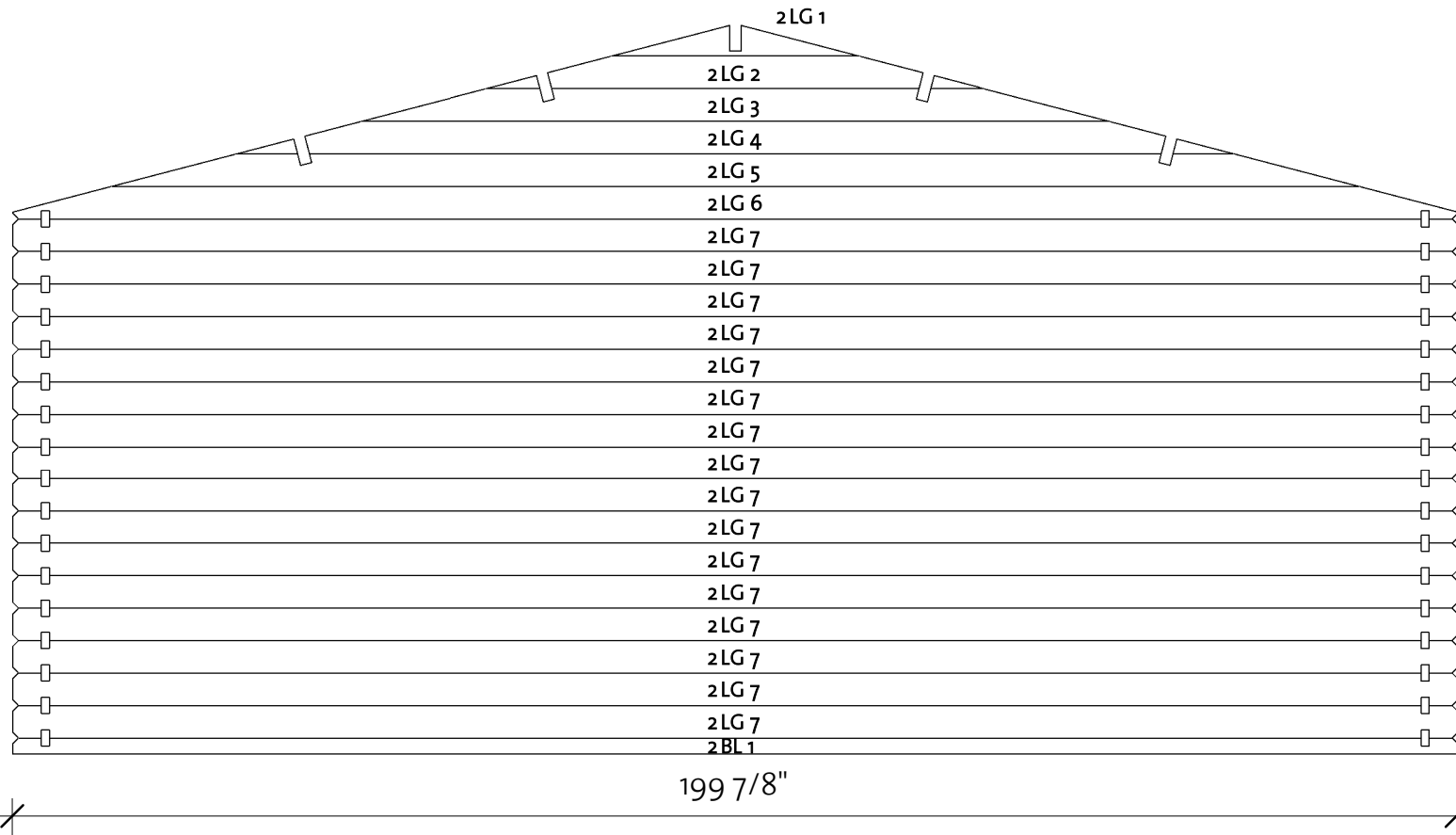
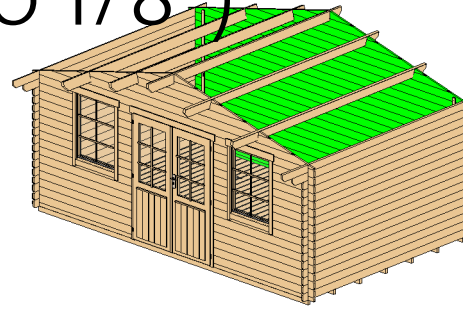

Wall 2			
Mark	Profile	Count	Cut Length

2BL 1	28x57	1	199 7/8"
2LG 1 *	28x114	1	34"
2LG 2 *	28x114	1	68 5/8"
2LG 3 *	28x114	1	103 1/4"
2LG 4 *	28x114	1	137 7/8"
2LG 5 *	28x114	1	172 1/2"
2LG 6 *	28x114	1	199 7/8"
2LG 7	28x114	16	199 7/8"

*Gable-delivered premounted

Log Profile Wall 2	
Profile	Profile

28x114	
28x57	

Toronto 160 28 (192 1/8" x 120 1/8")

Wall A

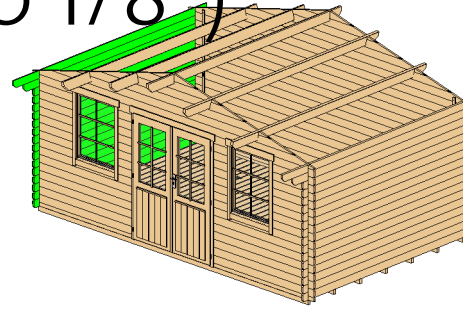

Wall A			
Mark	Profile	Count	Cut Length

ALG 1	28x114	15	127 7/8"
ALG 2	28x114	1	135 3/4"
ATL 1	28x114	1	147 1/2"

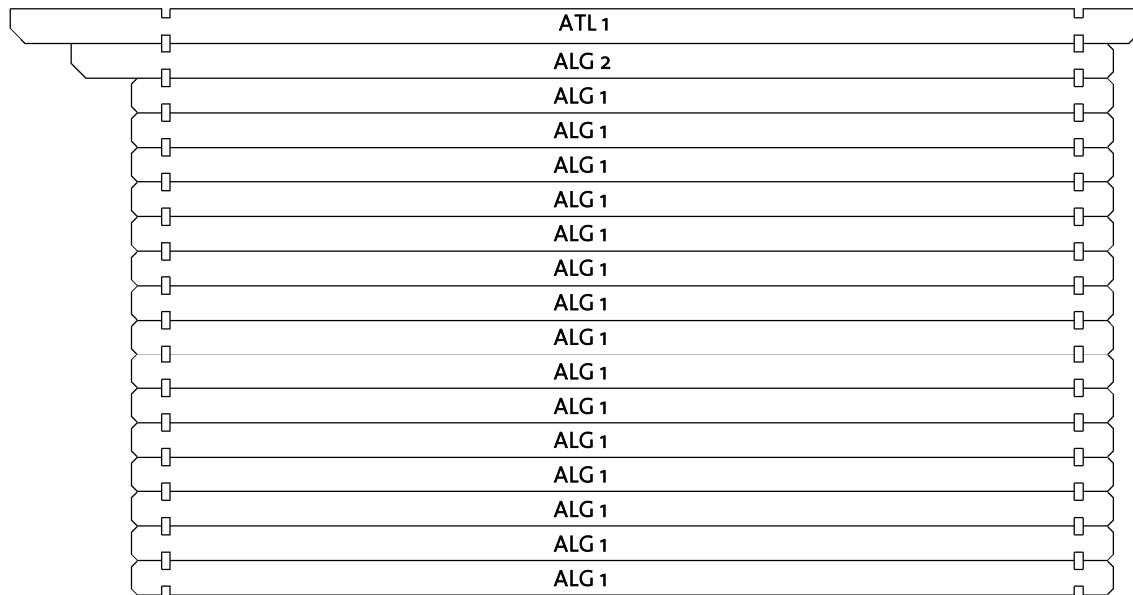

7 7/8" 7/8"

127 7/8"

3 7/8"

Log Profile Wall A	
Profile	Profile

28x114	
28x114	

Toronto 160 28 (192 1/8" x 120 1/8")

Wall B

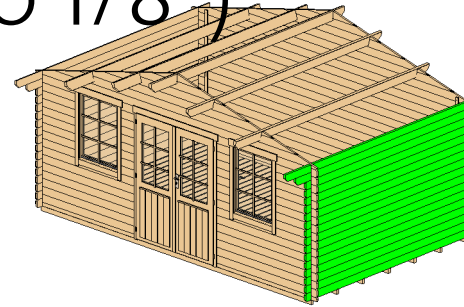

Wall B			
Mark	Profile	Count	Cut Length

BLG 1	28x114	15	127 7/8"
BLG 2	28x114	1	135 3/4"
BTL-1	28x114	1	147 1/2"

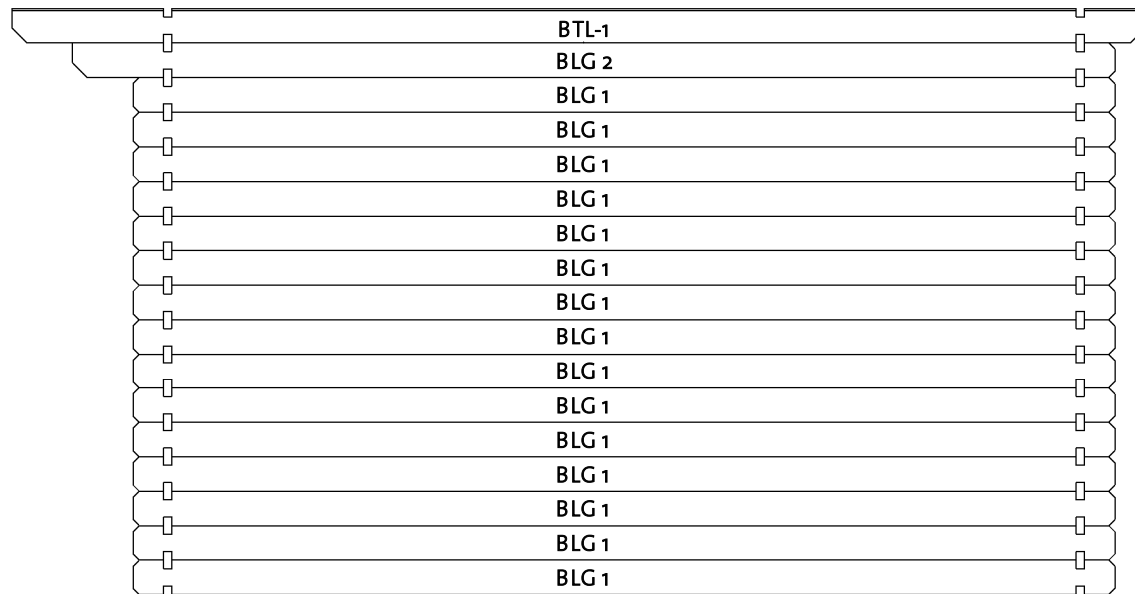

7 7/8" 7/8"

127 7/8"

3 7/8"



Log Profile Wall B	
Profile	Profile

28x114	
28x114	

Toronto 160 28 (192 1/8" x 120 1/8")

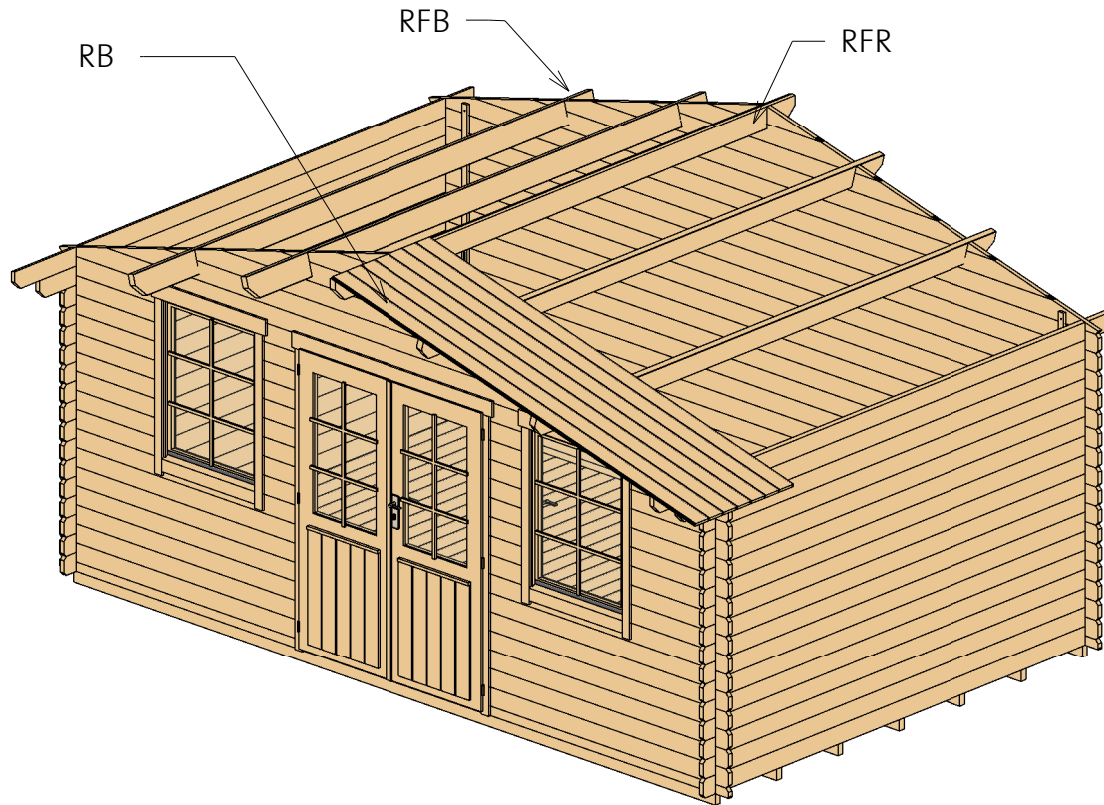
Roof 1



Roof				
Mark	Type	Profile	Count	Length
RFR	Ridge 40x143		1	147 1/2"
RFB	Beam 40x143		4	147 1/2"
RB	17x114		68	112"

Toronto 160 28 (192 1/8" x 120 1/8")

Roof 2

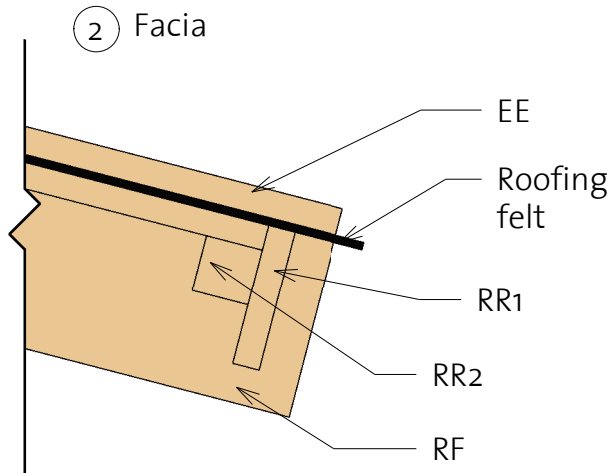
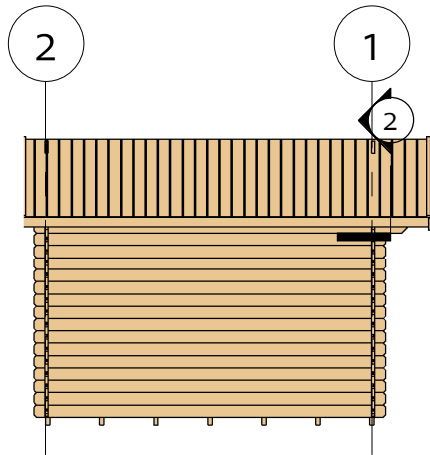

3 Roof Reinforcement

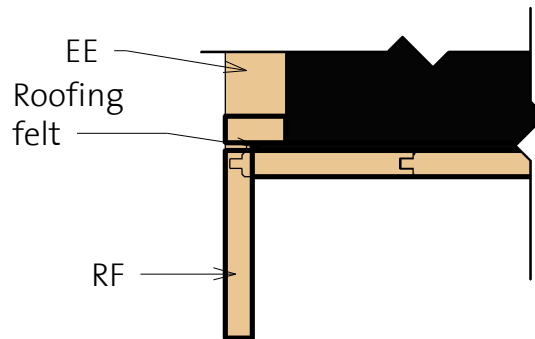
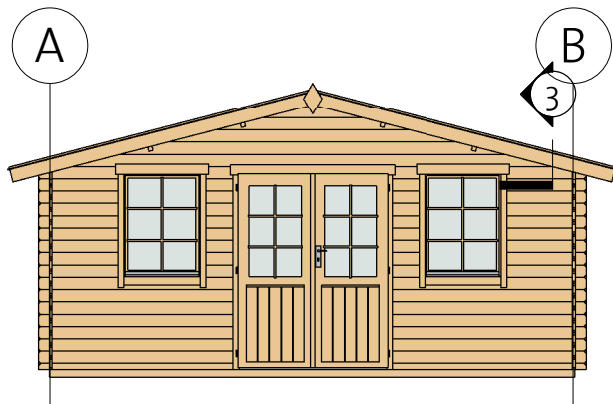

Fascia Schedule				
Mark	Type	Profile	Count	Length
EE	Eave Edging 18x40		4	114"
RF	Roof Fascia 18x120		4	114"
RR1	Roof reinforcement 18x95		2	147 1/2"
RR2	Roof reinforcement 38x38		2	147 1/2"

Toronto 160 28 (192 1/8" x 120 1/8")

Extras

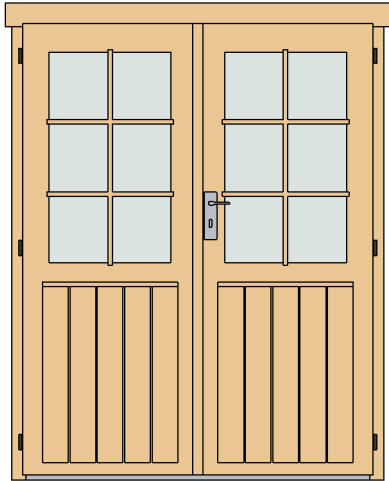

Door Schedule				
Model	Type	Width	Height	Count
BDD5R	Basic double door 5 right	56 1/8"	72 1/4"	1
DCB6	Door crossbar 6	--	--	2

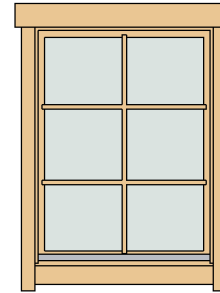

Window Schedule				
Model	Type	Width	Height	Count
BW1R	Basic window 1 right	30 1/8"	39"	1
BW1L	Basic window 1 left	30 1/8"	39"	1
WCB6	Window crossbar 6	--	--	2

Fasteners/Extras		
Name	Type	Count

Hitblock	300-400 mm	
Bolts	M8 x 60	12
Screws	5,0 x 70	15
nails	1,4 x 40	35
Screws	6,0 x 140	40
Screws	4,0 x 40	700

Type	Count	Length
Windboard 18x40	4	86 5/8"



Type	Count
------	-------

Romb	2
------	---

Toronto 160 28 (192 1/8"x120 1/8")

List of all items 1

Impregnated foundation beams

Mark	Type	Profile	Count	Length
------	------	---------	-------	--------

IFB	IFB 40x70		7	191 5/8"
-----	--------------	---	---	-------------

Floor Schedule

Mark	Type	Profile	Count	Length
------	------	---------	-------	--------

FB	FB 17x114		44	117 1/2"
----	-----------	---	----	----------

BB1	BB 20x40		2	192 7/8"
-----	-------------	---	---	-------------

BB2	BB 20x40		2	122"
-----	-------------	--	---	------

Roof

Mark	Type	Profile	Count	Length
------	------	---------	-------	--------

RFR	Ridge 40x143		1	147 1/2"
-----	-----------------	---	---	----------

RFB	Beam 40x143		4	147 1/2"
-----	----------------	---	---	----------

RB	17x114		68	112"
----	--------	---	----	------

Fascia Schedule

Mark	Type	Profile	Count	Length
------	------	---------	-------	--------

EE	Eave Edging 18x40		4	114"
----	----------------------	---	---	------

RF	Roof Fascia 18x120		4	114"
----	-----------------------	---	---	------

RR1	Roof reinforcement 18x95		2	147 1/2"
-----	--------------------------------	---	---	-------------

RR2	Roof reinforcement 38x38		2	147 1/2"
-----	--------------------------------	---	---	-------------

Toronto 160 28 (192 1/8"x120 1/8")

List of all items 2



Wall 1			
Mark	Profile	Count	Cut Length

1BL 1	28x57	2	71 5/8"
1LG 1 *	28x114	1	34"
1LG 2 *	28x114	1	68 5/8"
1LG 3 *	28x114	1	103 1/4"
1LG 4 *	28x114	1	137 7/8"
1LG 5 *	28x114	1	172 1/2"
1LG 6 *	28x114	1	199 7/8"
1LG 7	28x114	18	113 3/8"
1LG 8	28x114	18	29 7/8"
1LG 9	28x114	14	71 5/8"

Wall A			
Mark	Profile	Count	Cut Length

ALG 1	28x114	15	127 7/8"
ALG 2	28x114	1	135 3/4"
ATL 1	28x114	1	147 1/2"

Log Profiles	
Profile	Profile

28x57	
28x114	

Wall 2			
Mark	Profile	Count	Cut Length

2BL 1	28x57	1	199 7/8"
2LG 1 *	28x114	1	34"
2LG 2 *	28x114	1	68 5/8"
2LG 3 *	28x114	1	103 1/4"
2LG 4 *	28x114	1	137 7/8"
2LG 5 *	28x114	1	172 1/2"
2LG 6 *	28x114	1	199 7/8"
2LG 7	28x114	16	199 7/8"

*Gable-delivered premounted

Wall B			
Mark	Profile	Count	Cut Length

BLG 1	28x114	15	127 7/8"
BLG 2	28x114	1	135 3/4"
BTL-1	28x114	1	147 1/2"

Log Profiles	
Profile	Profile

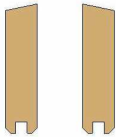
28x114	
--------	---