

Victoria C 1 9/16" (149 5/8" x 149 5/8")

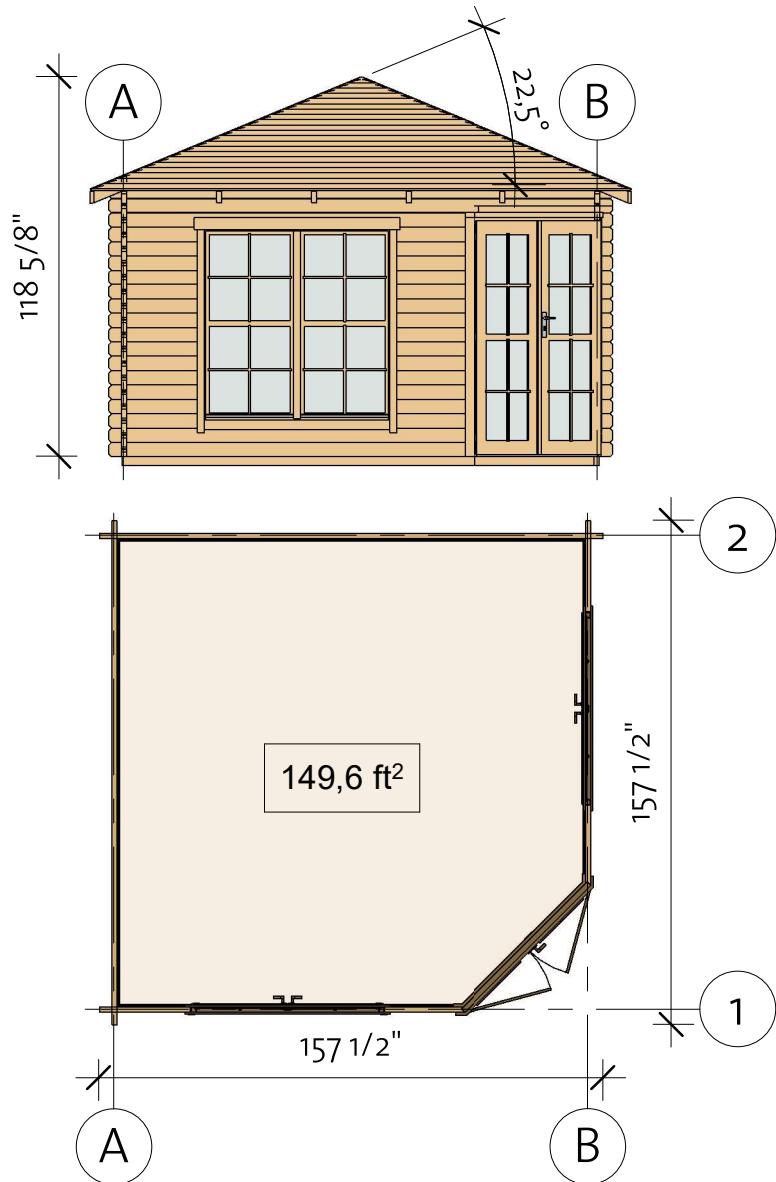

190523

Victoria C 1 9/16" (149 5/8" x 149 5/8")

Foundation

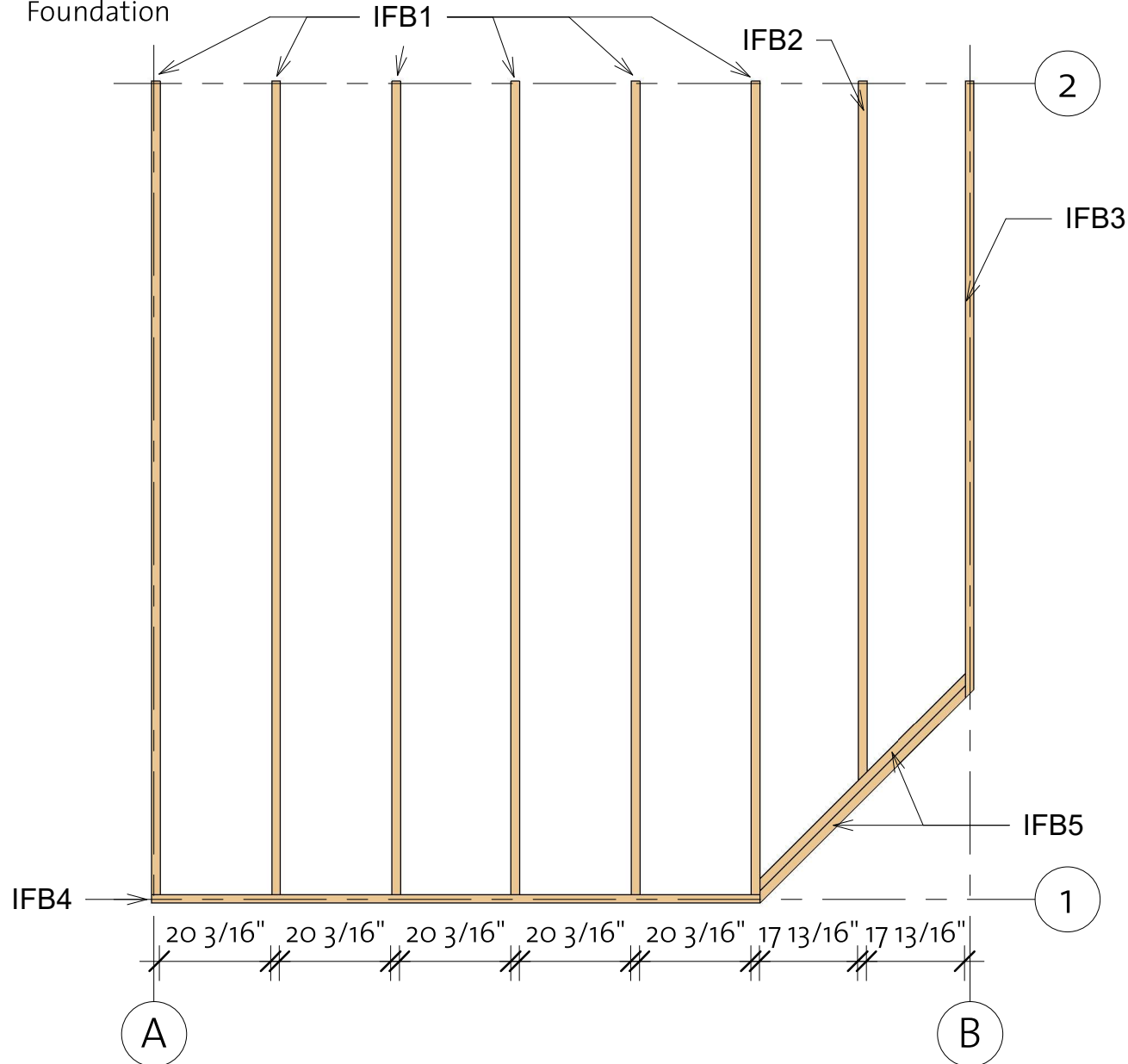

Impregnated foundation beams				
Mark	Type	Profile	Count	Length
IFB1	IFB 40x70		6	147 5/8"
IFB2	IFB 40x70		1	126 15/16"
IFB3	IFB 40x70		1	112"
IFB4	IFB 40x70		1	110 7/16"
IFB5	IFB 40x70		2	54 3/16"

Victoria C 1 9/16" (149 5/8"x149 5/8")

Floor Plan

① Baseboard

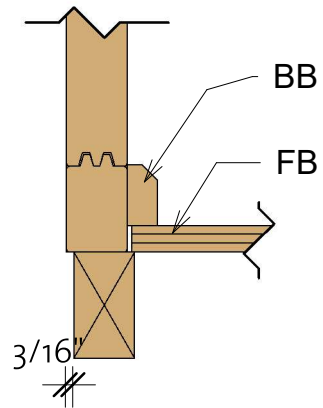

Floor Schedule				
Mark	Type	Profile	Count	Length

FB 1	FB 18x110		1	112 1/2"
FB 2	FB 18x110		1	116 13/16"
FB 3	FB 18x110		1	121 1/8"
FB 4	FB 18x110		1	125 1/2"
FB 5	FB 18x110		1	129 13/16"
FB 6	FB 18x110		1	134 1/8"
FB 7	FB 18x110		1	138 7/16"
FB 8	FB 18x110		1	142 13/16"
FB 9	FB 18x110		1	146 5/16"
FB 10	FB 18x110		26	146 5/16"

BB	BB 20x40		4	3800
----	----------	---	---	------

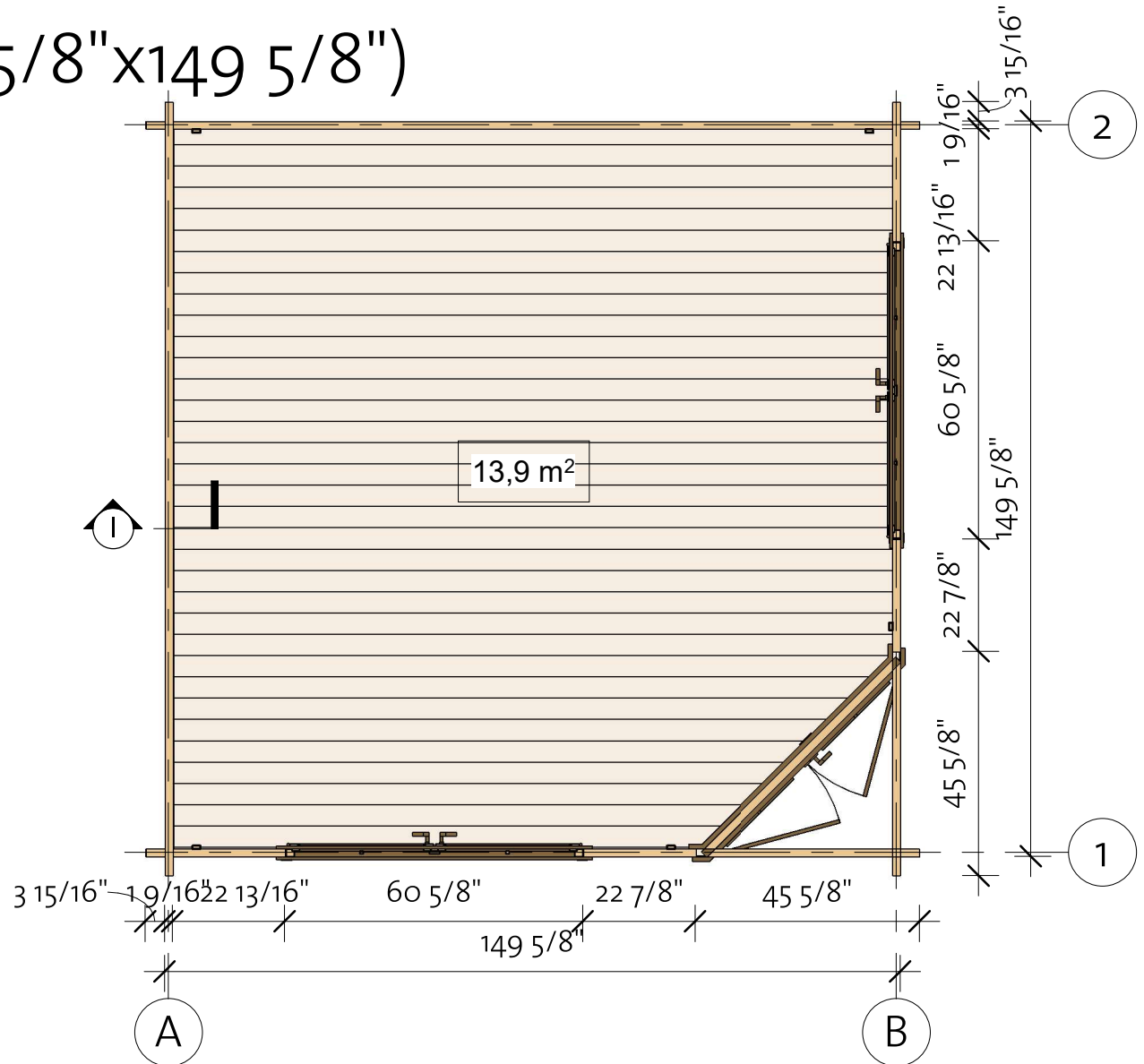

Victoria C 1 9/16" (149 5/8" x 149 5/8")

Wall 1

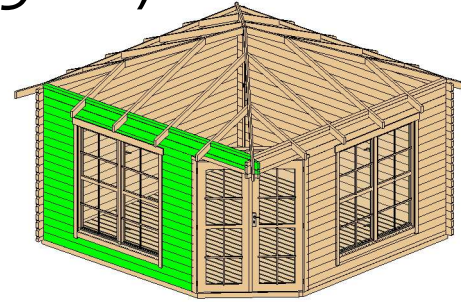

Wall 1			
Mark	Profile	Count	Cut Length

1LG-1	40x114	2	111 7/8"
1LG-2	40x114	13	22 7/8"
1LG-3	40x114	13	28 3/8"
1LG-4	40x114	1	157 1/2"
1LG-5	40x114	1	157 1/2"
1LG-6	40x114	1	111 7/8"
1LG-7	40x114	1	111 7/8"
1TL-1	40x63	3	28"
1TL-2	40x63	1	28 9/16"
1TL-3	40x63	1	28 9/16"

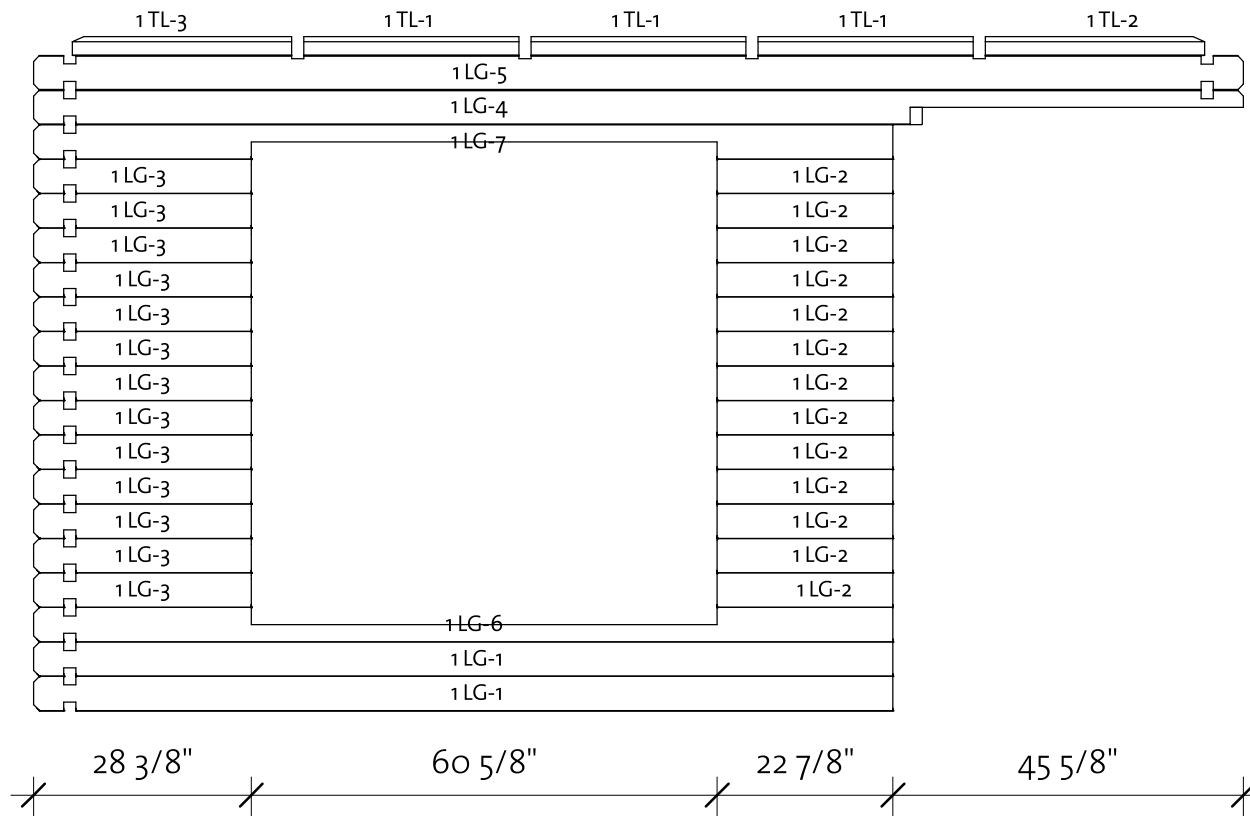

Log Profile Wall 1	
Profile	Profile

40x114	
40x114	
40x63	

Victoria C 1 9/16" (149 5/8"x149 5/8")

Wall 2

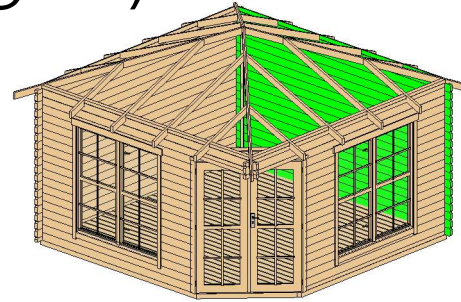

Wall 2			
Mark	Profile	Count	Cut Length

2LG-1	40x114	18	157 1/2"
2LG-2	40x114	1	157 1/2"
2TL-1	40x63	3	28"
2TL-2	40x63	1	28 9/16"
2TL-3	40x63	1	28 9/16"

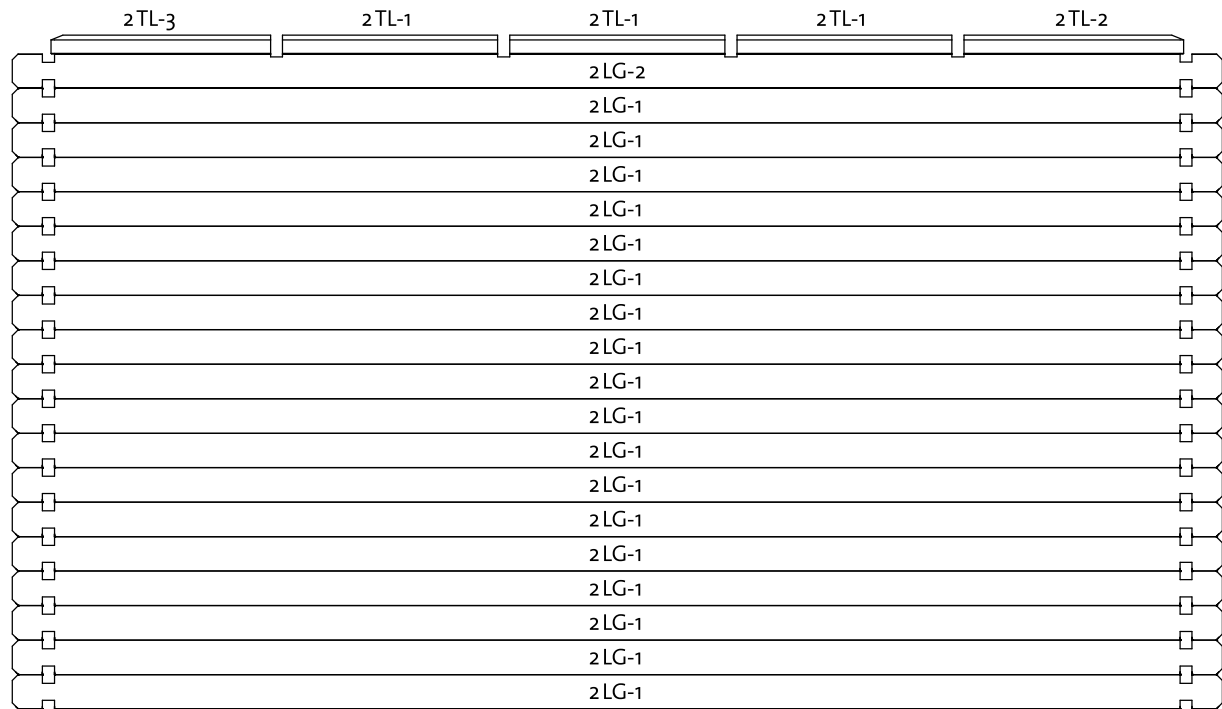

Log Profile Wall 2	
Profile	Profile



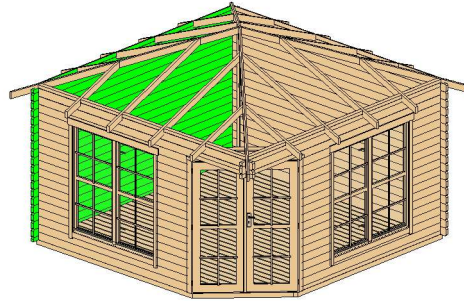

40x114	
40x114	
40x63	

Victoria C 1 9/16" (149 5/8" x 149 5/8")

Wall A



Wall A			
Mark	Profile	Count	Cut Length
ATL-1	40x63	3	28"
ATL-2	40x63	1	28 9/16"
ATL-3	40x63	1	28 9/16"
ABL-1	40x57	1	157 1/2"
ALG-1	40x114	18	157 1/2"
ATL-4	40x57 TL	1	157 1/2"

Log Profile Wall A	
Profile	Profile
40x57	
40x57 TL	
40x63	
40x114	

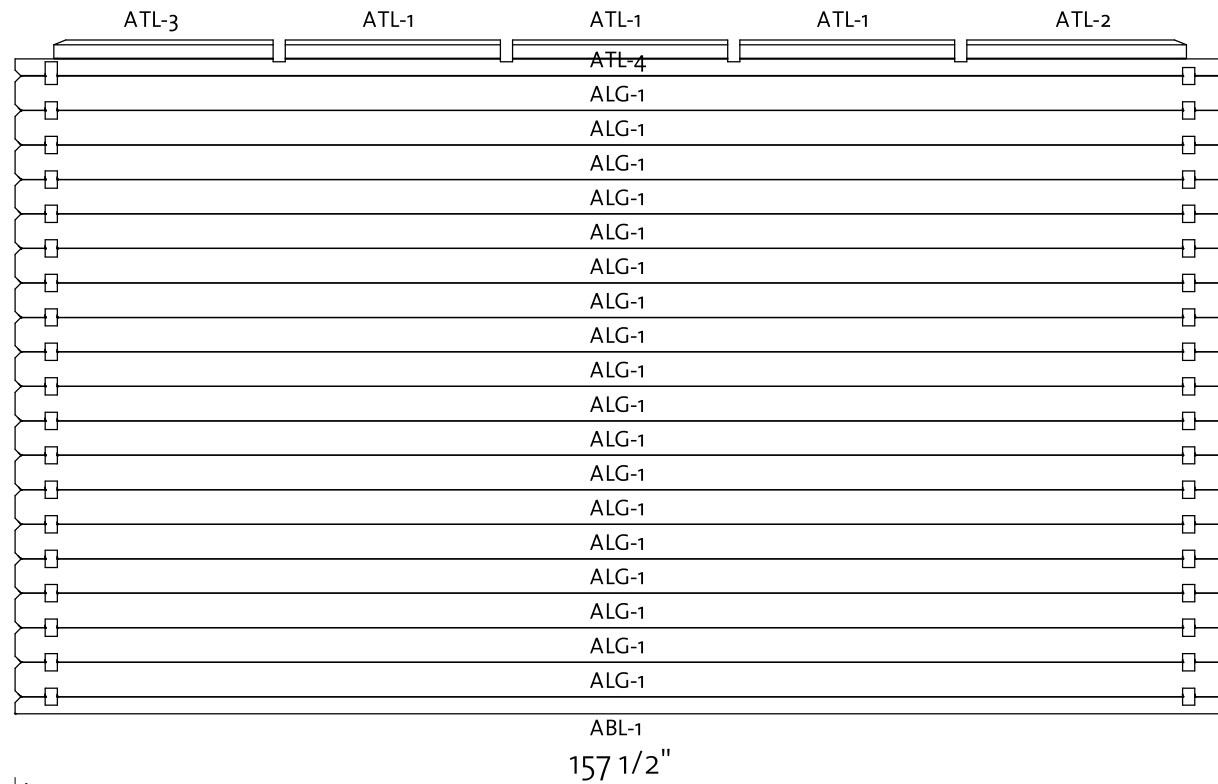

Victoria C 1 9/16" (149 5/8"x149 5/8")

Wall B

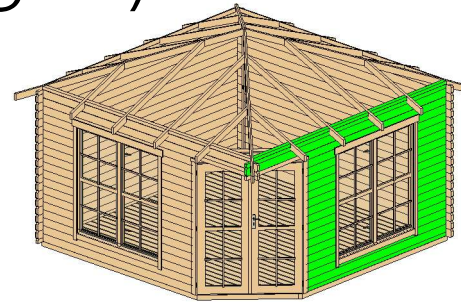

Wall B			
Mark	Profile	Count	Cut Length

BTL-1	40x63	3	28"
BTL-2	40x63	1	28 9/16"
BTL-3	40x63	1	28 9/16"
BBL-1	40x57	1	111 7/8"
BLG-1	40x114	14	22 7/8"
BLG-2	40x114	2	111 7/8"
BLG-3	40x114	1	115 11/16"
BLG-4	40x114	14	28 3/8"
BLG-6	40x114	1	157 1/2"
BTL-4	40x114	1	157 1/2"

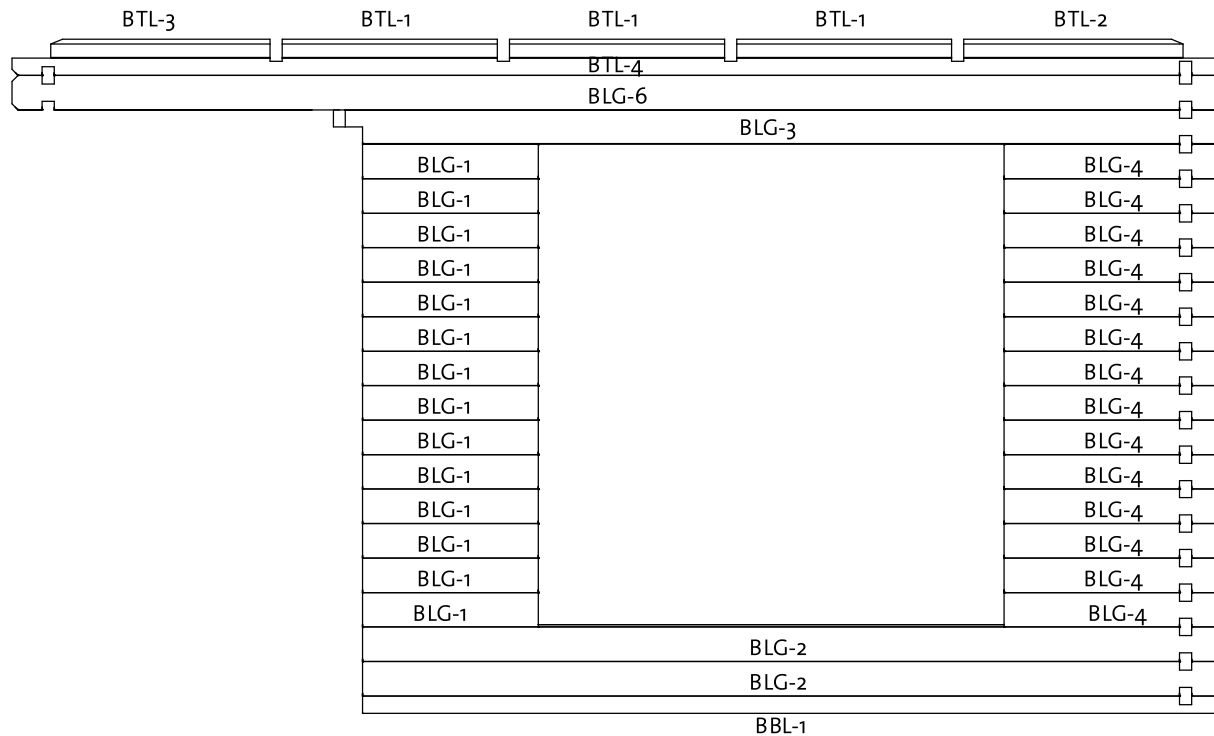

Log Profile Wall B	
Profile	Profile

40x57	
40x57 TL	

Log Profile Wall B	
Profile	Profile

40x63	
40x114	

Victoria C 1 9/16" (149 5/8"x149 5/8")

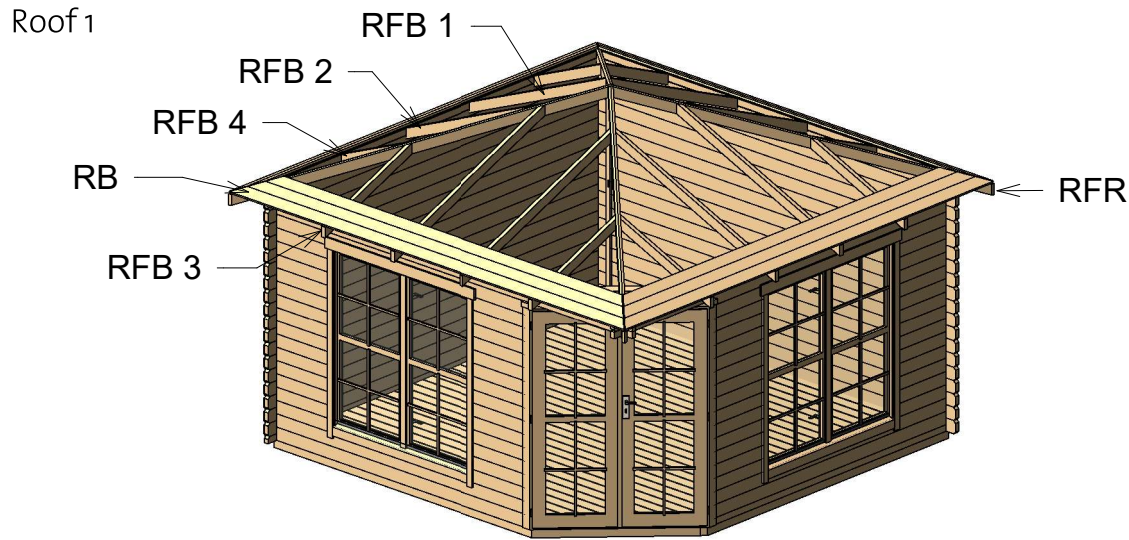

Roof				
Mark	Type	Profile	Count	Length

RFR	40x94		4	124 7/8"
RFB4	40x85		4	44 9/16"
RFB3	40x85		4	44 9/16"
RFB2	40x85		4	76 9/16"
RFB1	40x85		4	76 9/16"

Roofboards				
Mark	Type	Profile	Count	Length

RB 1	RoofBoard 18x110		4	8 9/16"
RB 2	RoofBoard 18x110		4	16 9/16"
RB 3	RoofBoard 18x110		4	24 9/16"
RB 4	RoofBoard 18x110		4	32 9/16"
RB 5	RoofBoard 18x110		4	40 9/16"
RB 6	RoofBoard 18x110		4	48 9/16"
RB 7	RoofBoard 18x110		4	56 9/16"
RB 8	RoofBoard 18x110		4	64 9/16"
RB 9	RoofBoard 18x110		4	72 9/16"

Roofboards				
Mark	Type	Profile	Count	Length

RB 10	RoofBoard 18x110		4	80 9/16"
RB 11	RoofBoard 18x110		4	88 9/16"
RB 12	RoofBoard 18x110		4	96 9/16"
RB 13	RoofBoard 18x110		4	104 9/16"
RB 14	RoofBoard 18x110		4	112 9/16"
RB 15	RoofBoard 18x110		4	120 9/16"
RB 16	RoofBoard 18x110		4	128 9/16"
RB 17	RoofBoard 18x110		4	136 5/8"
RB 18	RoofBoard 18x110		4	144 5/8"
RB 19	RoofBoard 18x110		4	152 5/8"
RB 20	RoofBoard 18x110		4	160 5/8"
RB 21	RoofBoard 18x110		4	168 5/8"

Victoria C 1 9/16" (149 5/8"x149 5/8")

Roof 2

Fascia Schedule				
Mark	Type	Profile	Count	Length

RF	Roof Fascia 18x120		4	169 13/16"
----	-----------------------	---	---	---------------

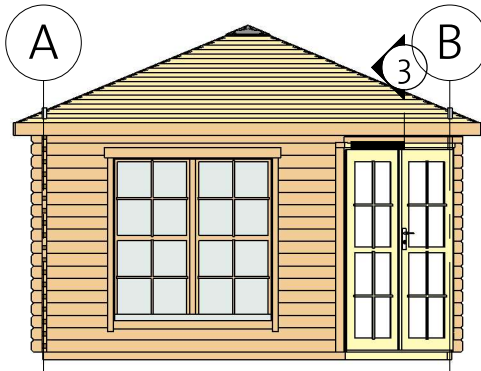

3 Facia

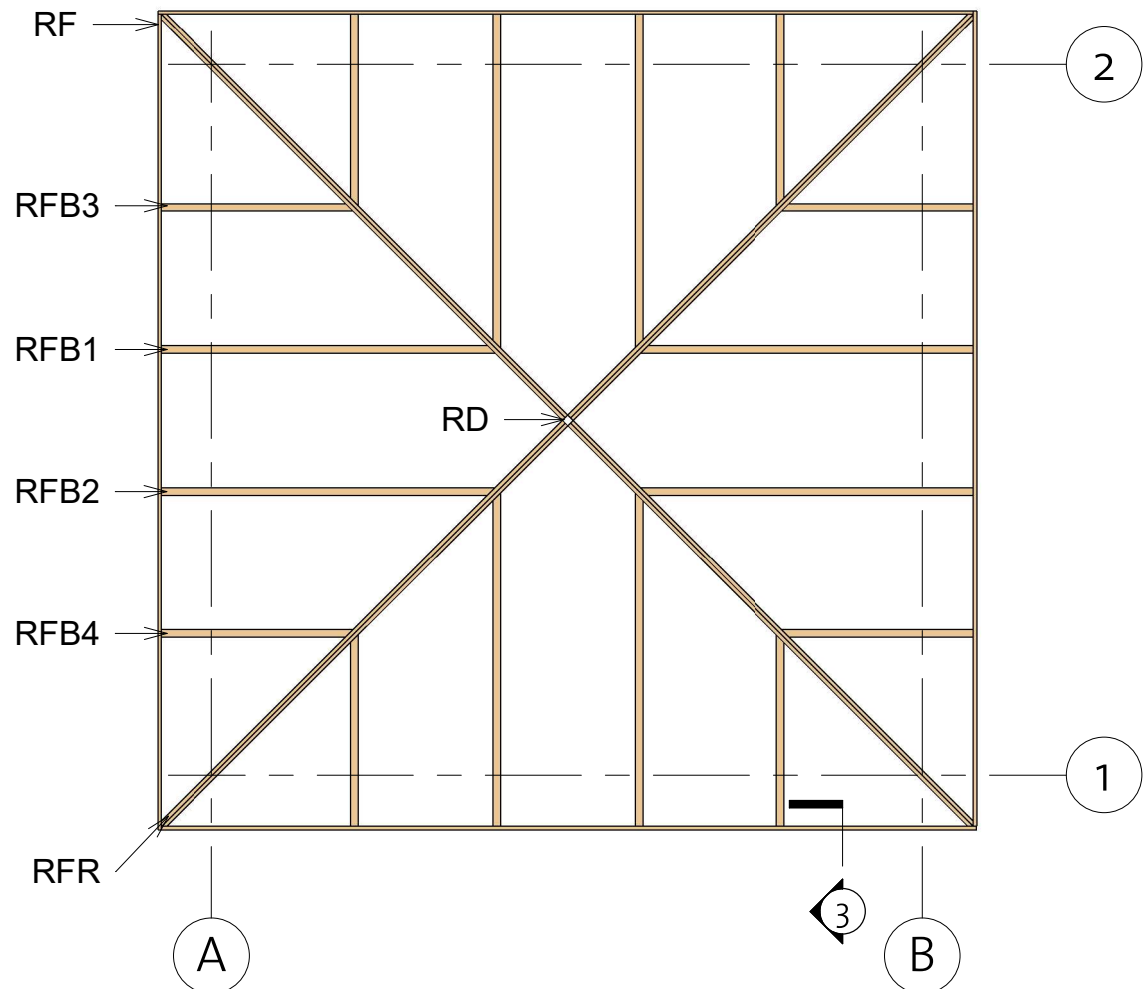
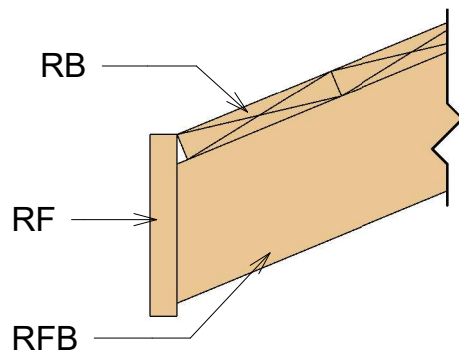

Victoria C 1 9/16" (149 5/8" x 149 5/8")

Extras

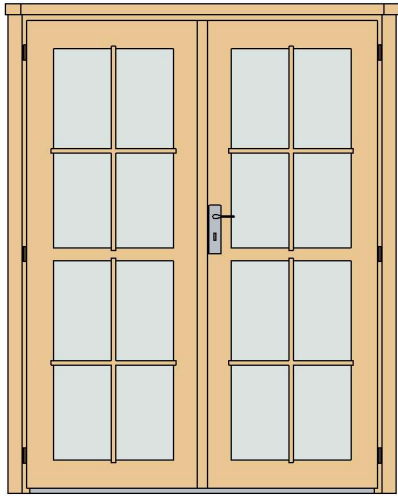

Door Schedule				
Model	Type	Width	Height	Count
CDD6R	Classic double door 6, two glass right	56 1/8"	74 13/16"	1

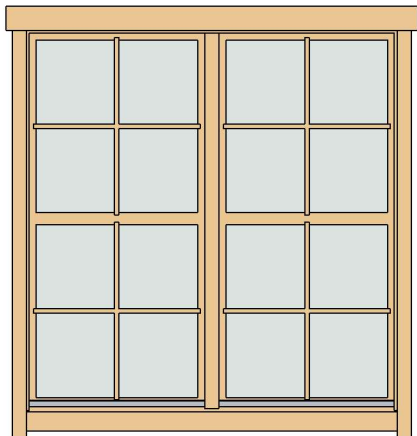

Window Schedule				
Model	Type	Width	Height	Count
CDW2	Classic double window 2	60 1/4"	61 1/4"	2



Type	Lenght	Count
Windboard 18x40	2200	5

Roof Detdail		
Mark	Type	Count

RD	Roof detail	1
----	-------------	---



Fasteners/Extras		
Name	Type	Count

Hitblock	11 13/16"-15 3/4"	
Bolts	M5/16" x 2 3/4"	15
Nails	1/16" x 1 9/16"	40
Screws	3/16" x 2 3/4"	60
Screws	3/16" x 1 9/16"	65
Screws	1/4" x 5 1/2"	110
Screws	3/16" x 2"	850

① Roof top

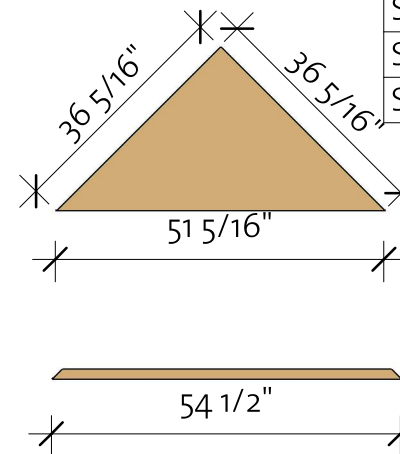
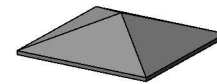

Type	Mark	Count
------	------	-------

Ceiling detail 40x120	CD	1
Ceiling triangle	CT	1

Victoria C 1 9/16" (149 5/8"x149 5/8")

List of all items 1

Impregnated foundation beams				
Mark	Type	Profile	Count	Length

IFB1	IFB 40x70		6	147 5/8"
IFB2	IFB 40x70		1	126 15/16"
IFB3	IFB 40x70		1	112"
IFB4	IFB 40x70		1	110 7/16"
IFB5	IFB 40x70		2	54 3/16"

Floor Schedule				
Mark	Type	Profile	Count	Length

FB 1	FB 18x110		1	112 1/2"
FB 2	FB 18x110		1	116 13/16"
FB 3	FB 18x110		1	121 1/8"
FB 4	FB 18x110		1	125 1/2"
FB 5	FB 18x110		1	129 13/16"
FB 6	FB 18x110		1	134 1/8"
FB 7	FB 18x110		1	138 7/16"
FB 8	FB 18x110		1	142 13/16"
FB 9	FB 18x110		1	146 5/16"
FB 10	FB 18x110		26	146 5/16"

BB	BB 20x40		4	3800
----	-------------	---	---	------

Victoria C 1 9/16" (149 5/8"x149 5/8")

List of all items 2

Wall 1			
Mark	Profile	Count	Cut Length

1LG-1	40X114	2	111 7/8"
1LG-2	40X114	13	22 7/8"
1LG-3	40X114	13	28 3/8"
1LG-4	40X114	1	157 1/2"
1LG-5	40X114	1	157 1/2"
1LG-6	40X114	1	111 7/8"
1LG-7	40X114	1	111 7/8"
1TL-1	40X63	3	28"
1TL-2	40X63	1	28 9/16"
1TL-3	40X63	1	28 9/16"

Wall A			
Mark	Profile	Count	Cut Length

ATL-1	40X63	3	28"
ATL-2	40X63	1	28 9/16"
ATL-3	40X63	1	28 9/16"
ABL-1	40X57	1	157 1/2"
ALG-1	40X114	18	157 1/2"
ATL-4	40X57 TL	1	157 1/2"

Wall 2			
Mark	Profile	Count	Cut Length

2LG-1	40X114	18	157 1/2"
2LG-2	40X114	1	157 1/2"
2TL-1	40X63	3	28"
2TL-2	40X63	1	28 9/16"
2TL-3	40X63	1	28 9/16"



Wall B			
Mark	Profile	Count	Cut Length

BTL-1	40X63	3	28"
BTL-2	40X63	1	28 9/16"
BTL-3	40X63	1	28 9/16"
BBL-1	40X57	1	111 7/8"
BLG-1	40X114	14	22 7/8"
BLG-2	40X114	2	111 7/8"
BLG-3	40X114	1	115 11/16"
BLG-4	40X114	14	28 3/8"
BLG-6	40X114	1	157 1/2"
BTL-4	40X114	1	157 1/2"

Log Profiles	
Profile	Profile

40X114	
--------	---

Log Profiles	
Profile	Profile

40X63	
40X114	
40X57 TL	

Victoria C 1 9/16" (149 5/8"x149 5/8")

List of all items 3

Roofboards				
Mark	Type	Profile	Count	Length



RB 1	RoofBoard 18x110		4	8 9/16"
RB 2	RoofBoard 18x110		4	16 9/16"
RB 3	RoofBoard 18x110		4	24 9/16"
RB 4	RoofBoard 18x110		4	32 9/16"
RB 5	RoofBoard 18x110		4	40 9/16"
RB 6	RoofBoard 18x110		4	48 9/16"
RB 7	RoofBoard 18x110		4	56 9/16"
RB 8	RoofBoard 18x110		4	64 9/16"
RB 9	RoofBoard 18x110		4	72 9/16"
RB 10	RoofBoard 18x110		4	80 9/16"
RB 11	RoofBoard 18x110		4	88 9/16"
RB 12	RoofBoard 18x110		4	96 9/16"
RB 13	RoofBoard 18x110		4	104 9/16"
RB 14	RoofBoard 18x110		4	112 9/16"
RB 15	RoofBoard 18x110		4	120 9/16"
RB 16	RoofBoard 18x110		4	128 9/16"
RB 17	RoofBoard 18x110		4	136 5/8"
RB 18	RoofBoard 18x110		4	144 5/8"
RB 19	RoofBoard 18x110		4	152 5/8"
RB 20	RoofBoard 18x110		4	160 5/8"
RB 21	RoofBoard 18x110		4	168 5/8"

Fascia Schedule				
Mark	Type	Profile	Count	Length

RF	Roof Fascia 18x120		4	169 13/16"
----	-----------------------	---	---	---------------

Victoria C 1 9/16" (149 5/8"x149 5/8")

List of all items 4

Roof				
Mark	Type	Profile	Count	Length
RFR	40x94		4	124 7/8"
RFB4	40x85		4	44 9/16"
RFB3	40x85		4	44 9/16"
RFB2	40x85		4	76 9/16"
RFB1	40x85		4	76 9/16"